



GT SYSTEM









Apartment Intercom System

PRECAUTIONS

 General Prohibitions  Prohibition to Dismantle the Unit  Prohibition on Subjecting the Unit to Water  General Precautions













WARNING

(Negligence could result in death or serious injury.)

-  1. The units must be installed and wired by a qualified technician. Having installation performed by an unqualified technician could result in electric shock.
-  2. Do not dismantle or alter the unit. Fire or electric shock could result.
-  3. Do not connect non-specified power sources to the +, - terminals. Also, do not install two power supplies in parallel to a single input. Fire, damage, or system malfunction could result.
-  4. Keep the unit away from water or any other liquid. Fire or electric shock could result.
-  5. Do not remove the power supply plug with wet hands. Electric shock could result.
-  6. Do not put any metal or paper into the unit through the openings. Fire, electric shock, or unit trouble could result.
-  7. High voltage is present internally. Do not open the case. Electric shock could result.
-  8. Do not connect any terminal on the unit to an AC power line. Fire or electric shock could result.

CAUTION

(Negligence could result in injury to people or damage to property.)

-  1. Before turning on power, make sure wires are not crossed or shorted. If not, fire or electric shock could result.
-  2. When performing call tests or checking the chime volume or call volume, make sure the handset is placed on the main unit. Failure to do so may result in injury to the ears.
-  3. Do not install or make any wire terminations while the power supply is turned on. This can cause electrical shock or damage to the unit.
-  4. Do not place (install) the unit in locations subject to frequent vibration or impact. Injury or damage could result if the unit falls.
-  5. When mounting the unit on a wall, install the unit in a convenient location, but not where it could be jarred or bumped. Injury could result.
-  6. Do not alter or change the wall-mounting area of the unit. This could result in injury if the unit falls or if something comes in contact with the unit.
-  7. Do not apply force to the television monitor. Damage or injury could result.
-  8. If the LCD is punctured, do not allow skin contact with the liquid crystal inside. Inflammation could result. If liquid crystal is ingested, immediately gargle with water and seek medical attention. If contact with the eyes or skin occurs, clean with pure water for at least 15 minutes and seek medical attention.
-  9. When washing the wall surface with high-pressure water, make sure water does not get on the entrance station. Fire or electric shock could result.
-  10. Do not install the unit in any of the following locations. Fire, electric shock, or unit trouble could result.
 - * Places under direct sunlight or places near heating equipment that varies in temperature.
 - * Places subject to dust, oil, chemicals, etc.
 - * Places subject to moisture and humidity extremes, such as bathrooms, cellars, greenhouses, etc.
 - * Places where the temperature is quite low, such as inside a refrigerated area or in front of an air conditioner.
 - * Places subject to steam or smoke (near heating or cooking surfaces).
 - * Where noise generating devices such as dimmer switches or inverter electrical appliances are close by.
-  11. Do not put anything on or cover the unit with cloth, etc. Fire or unit trouble could result.
-  12. For power supply, use Aiphone power supply model or model specified for use with system. If non-specified product is used, fire or malfunction could result.

General Precautions

1. All units, except for the entrance station, are designed for indoor use only. Do not use outdoors.
2. The unit turns inoperative during power failure.
3. In areas where broadcasting station antennas are close by, intercom system may be affected by radio frequency interference.
4. Keep the intercom wires at least 30 cm away from strong electrical wiring (AC 100-240 V) including, in particular, wiring for inverter electrical appliances. Noise and malfunction could result.
5. Keep the unit more than 1 m away from radio or TV set.
6. If a strong light shines on the main unit screen, the picture will turn white or only silhouettes will be visible. But this is not a unit malfunction.
7. As to other manufacturer's devices (such as sensor, detectors, door releases) used with this system, comply with the Specifications and Warranty conditions that the manufacturers or vendors present.
8. The LCD panel is manufactured with very high precision techniques. Please be aware of this in advance.
9. The sensor of an entrance station (Integrated type) may activate due to moving shadows or moving tree branches, etc. and cause a message to display, but this is not a malfunction.

Table of Contents

1	SYSTEM CONFIGURATIONS	
	Standard system configuration	4
	Expanded system configuration diagram	5
	Residential station configuration	6
	Wiring distance.....	8
2	COMPONENTS	
	Entrance Station (Unit type).....	10
	Entrance Station (Integrated type), Bus control unit etc., Residential station	12
	Door station, Security guard station.....	13
3	MOUNTING	
	Mounting locations, Appropriate cable.....	14
	Mounting positions and image view area	15
	Entrance Station (Unit type).....	16
	Entrance Station (Integrated type)	18
	Bus control unit, 4-way video junction unit and power supply	19
	Residential station.....	20
	Door station.....	22
	Security guard station.....	23
4	WIRING	
	Standard system for common area	24
	Standard system for residence (station-to-station wiring)	26
	Standard system for residence (homerun wiring)	27
	Expanded system	28
	Option connector	30
	External signaling relay connection	31
5	SETTINGS (COMMON AREA)	
	Setting list	32
	Setting method.....	33
	Entrance station and security guard station ID setting, Changing the ID code	34
	Writing resident information.....	35
	Manual setting of residence IDs, Setting up the system	36
	Transferring link information	40
	Link check.....	41
	Setting the input timeout timer	42
	Display language selection, Guidance language selection	43
	Setting messages and the standby screen.....	44
	Room number display setting, Scroll speed setting	45
	Setting the sort order for searching	46
	Access code setting	47
	Entrance monitor setting, Call screen setting.....	48
	Surveillance camera switching setting, Adjusting screen brightness.....	49
	LCD operation mode setting, Security guard station transfer setting, Setting prohibition on calls from security guard stations.....	50
	Entrance zoom picture pre-set	51
	Visibility settings (daytime only).....	52
	Entrance night illumination setting, Direct select type light button setting	53
6	Setting (GT-2C-L/GT-2C)	
	How to use the MENU, Security guard station settings.....	54
	Emergency input settings, External input setting.....	55
	Doctor call setting, Press-to-talk setting	57
	Initializing.....	58
7	TECHNICAL PRECAUTIONS.....	58

1 SYSTEM CONFIGURATIONS

1-1 Standard system configuration

This system is constructed with a 2-line communication system and a 2-line video system and requires minimal work for installation. The system is constructed with video trunk lines consisting of a maximum of 6 trunks from the video bus control system and communication trunk lines that use a distribution point from a bus control unit. In addition, systems with audio only can be configured.

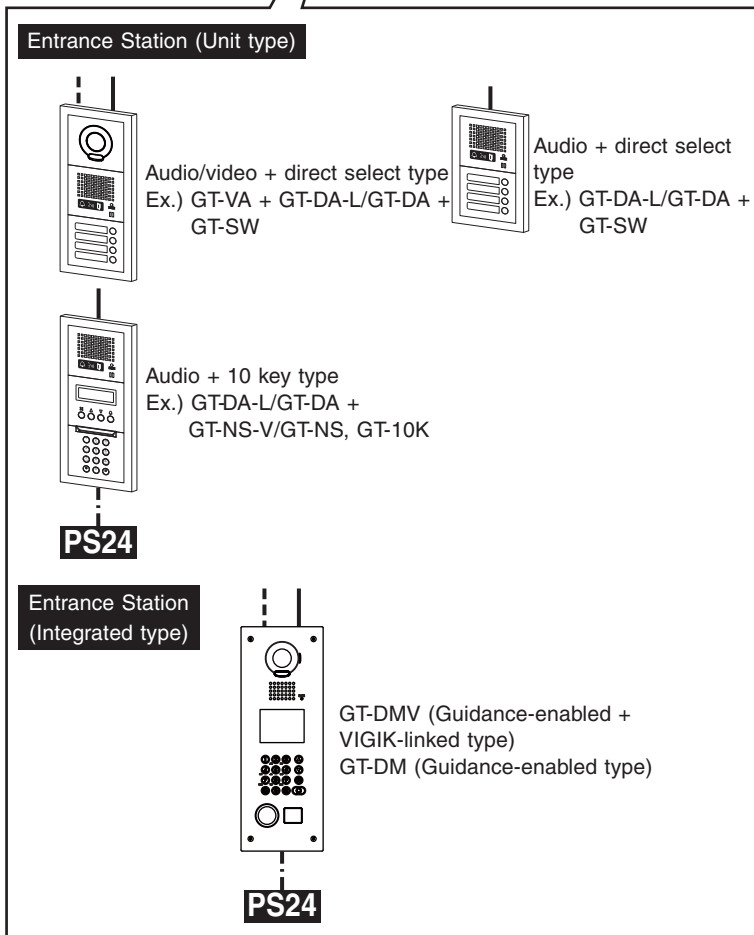
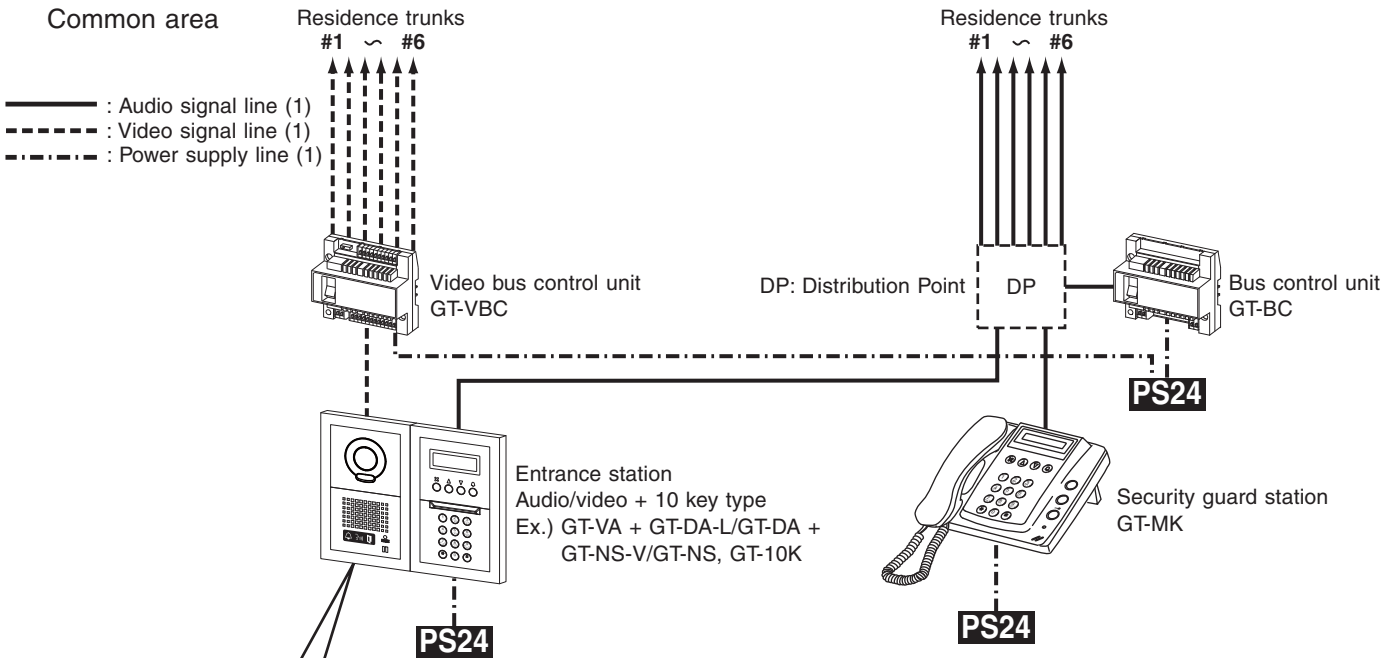

	Capacity
Entrance station	Maximum 5 stations (maximum 3 stations per trunk) *1
Security guard station	Maximum 2 stations
Residential station	Maximum 48 stations (maximum 25 stations per trunk) *2
Residential stations in the same residence (other than GT-2C)	Maximum 4 stations (2 monitor stations)
4-way video junction unit (see page 6)	Maximum 6 units per trunk
Bus control unit	Maximum 1 unit
Video bus control unit	Maximum 1 unit
Master stations in the same residence (GT-2C)	Maximum station
Sub master monitor station	Maximum 3 stations

*1 If an external door release button is connected to a direct select type entrance station, a maximum of 3 stations can be connected to a standard system.

*2 The maximum is 100 stations with the GT-1D and GT-1M-L only.
 (GT-1D: Maximum 50 stations per trunk
 GT-1M-L: Maximum 25 stations per trunk)

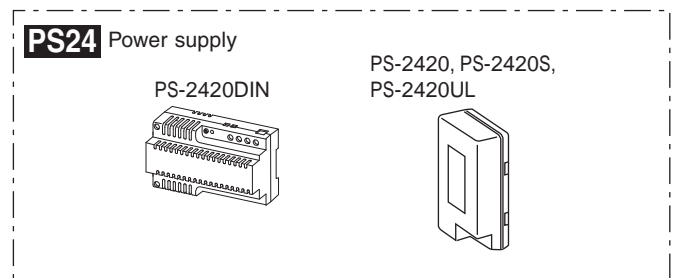

1-2 Expanded system configuration diagram

The wiring of the sub trunk line is the same as the standard system.

Common area

- : Audio signal line (1)
- - - : Video signal line (1)
- · - · - : Power supply line (1)

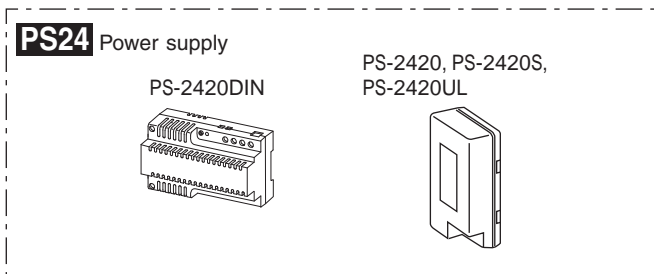
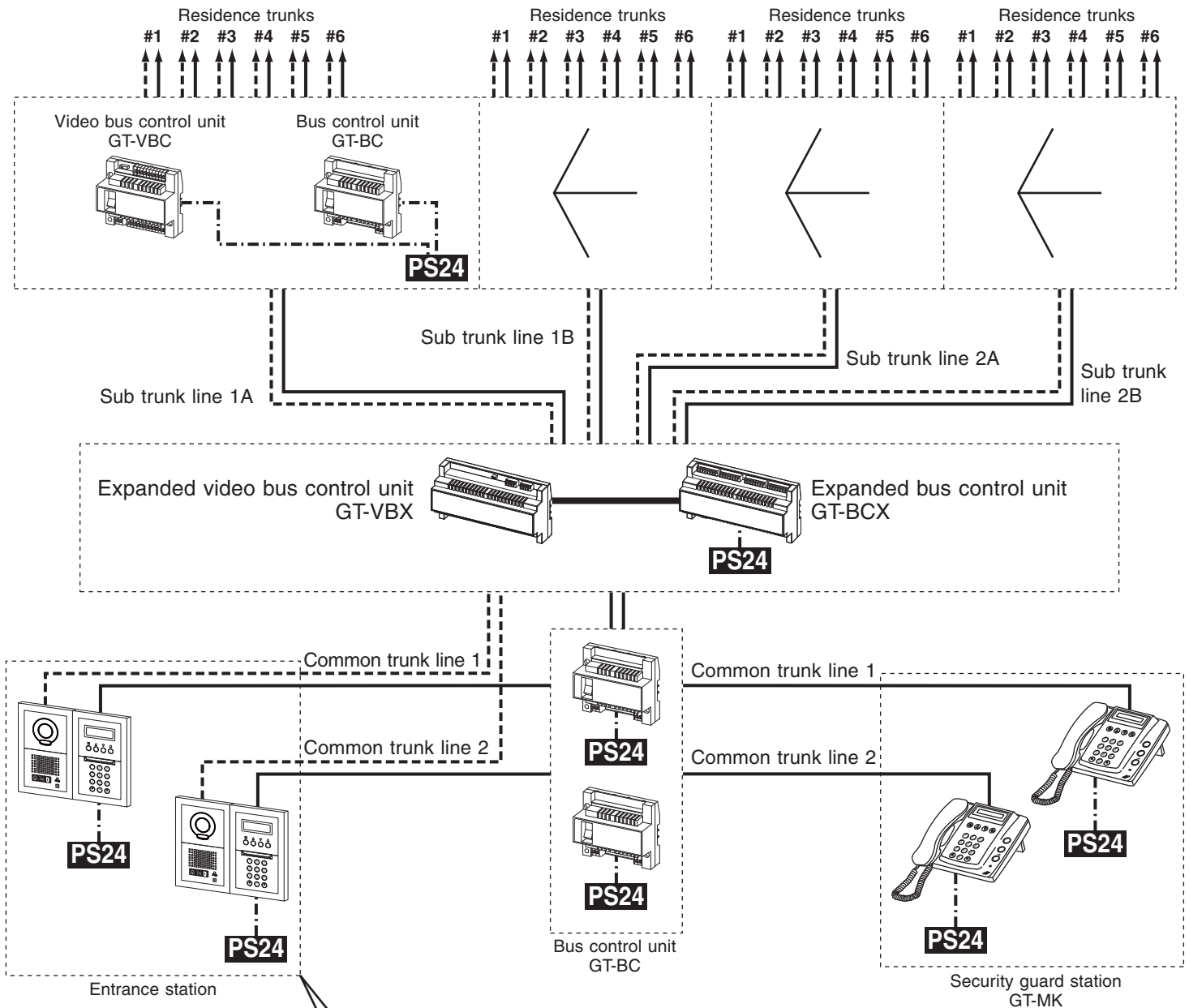

	Capacity
Entrance station	Maximum 16 stations (up to 8 stations per trunk)
Residential stations per sub trunk line	Maximum 125 stations (up to 25 stations per trunk)
Security guard station	Maximum 4 stations
Residential station	Maximum 500 stations
Residential stations in the same residence (other than GT-2C)	Maximum 4 stations (2 monitor stations)
Bus control units per common trunk line	Maximum 1 unit
Bus control units per sub trunk line	Maximum 1 unit
Master stations in the same residence (GT-2C)	Maximum station
Sub master monitor station	Maximum 3 stations

1-3 Residential station configuration

For wiring from the control units to each residence, station-to-station wiring or star wiring using a 4-way video junction unit is possible.

⚠ Mixing on the same trunk line is not possible.

- : Audio signal line (1)
- - - : Video signal line (1)
- · - · - : Power supply line (1)

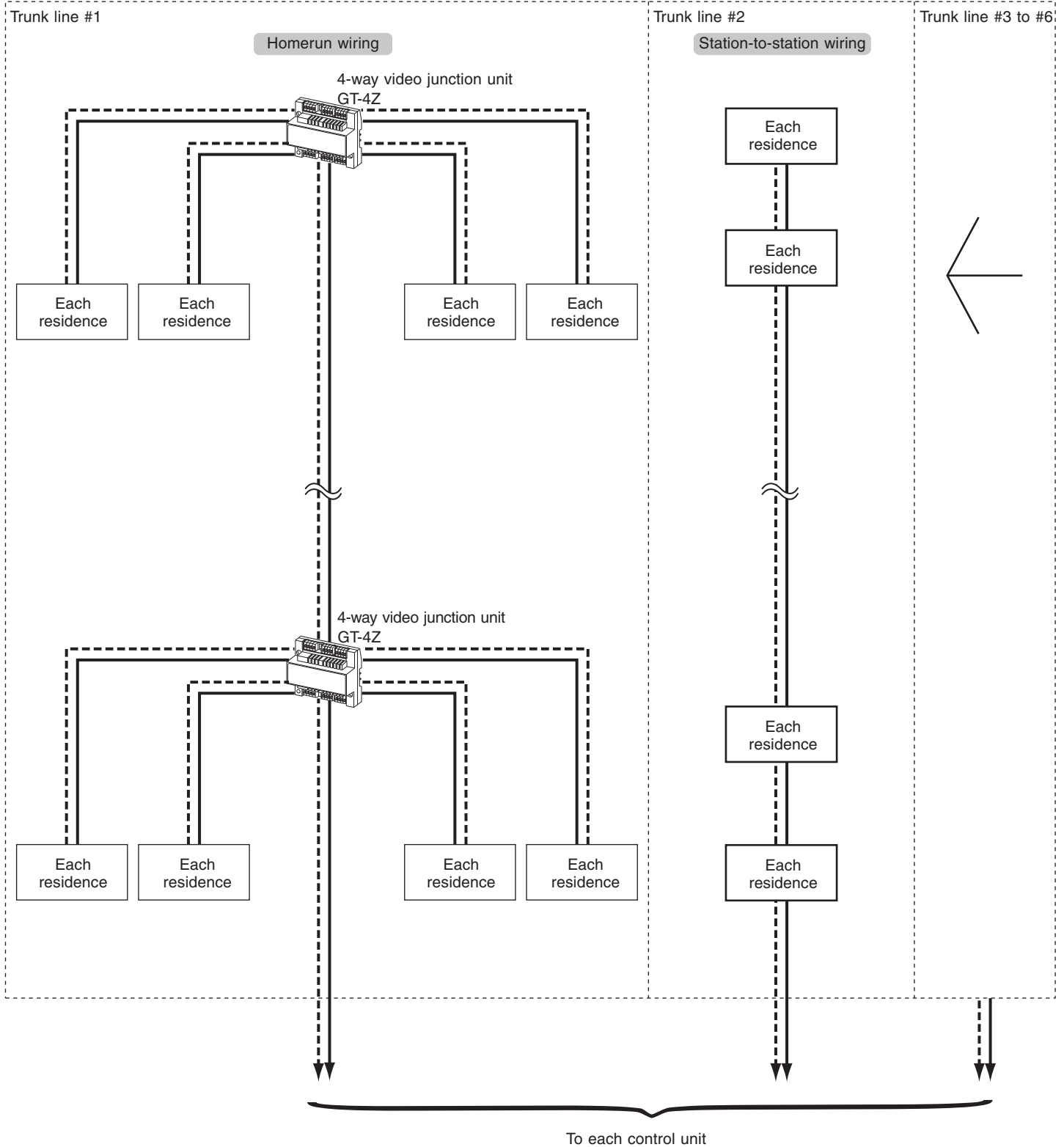

Each residence (with recording function)

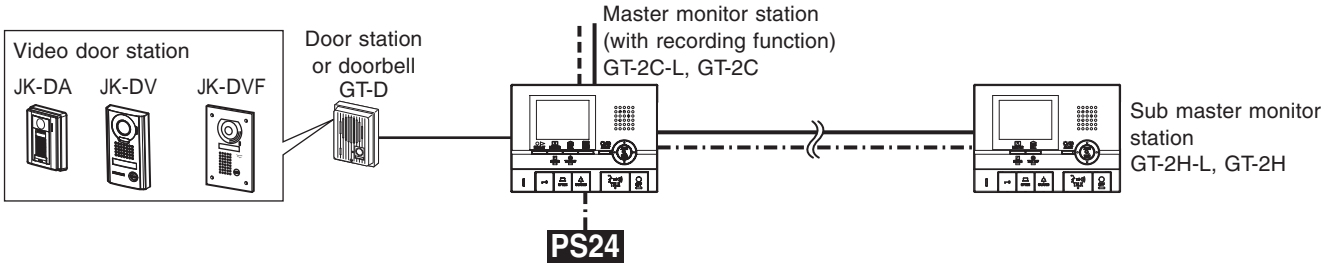

Power supply-related

[When sub master monitor stations are connected]

If even just one sub master monitor station is connected, it is possible to supply power to up to 2 residences with 1 PS24 power supply. However, wiring must be connected from near the terminals of the power supply for each residence.

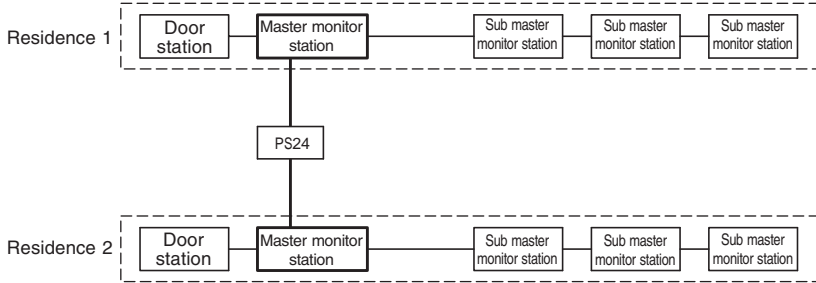

[When sub master monitor stations are not connected]

It is possible to supply power to up to 4 residences with 1 PS24 power supply. However, wiring must be connected from near the terminals of the power supply for each residence.

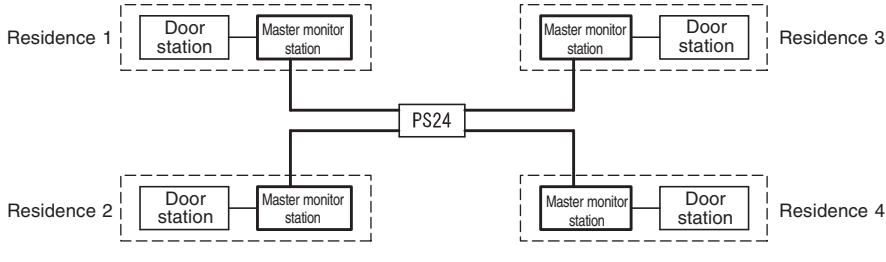

Each residence (with monitor)

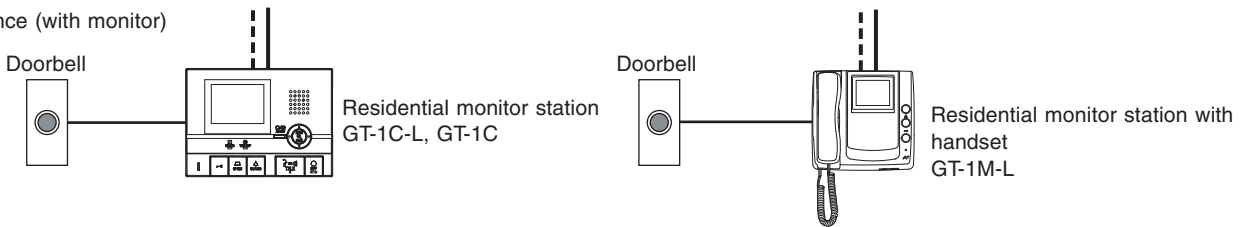

Each residence (with audio)

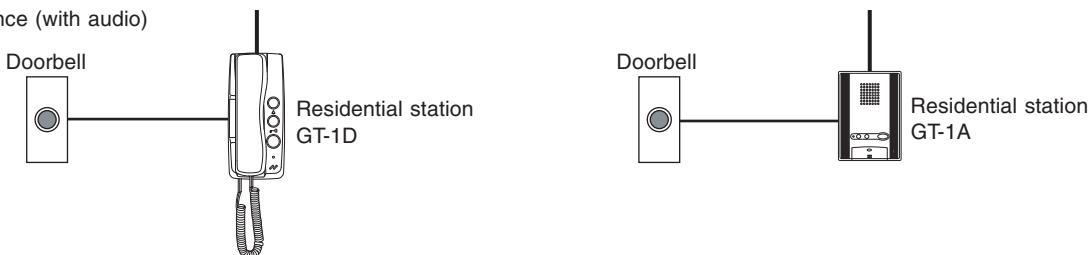

1-4 Wiring distance

Standard system

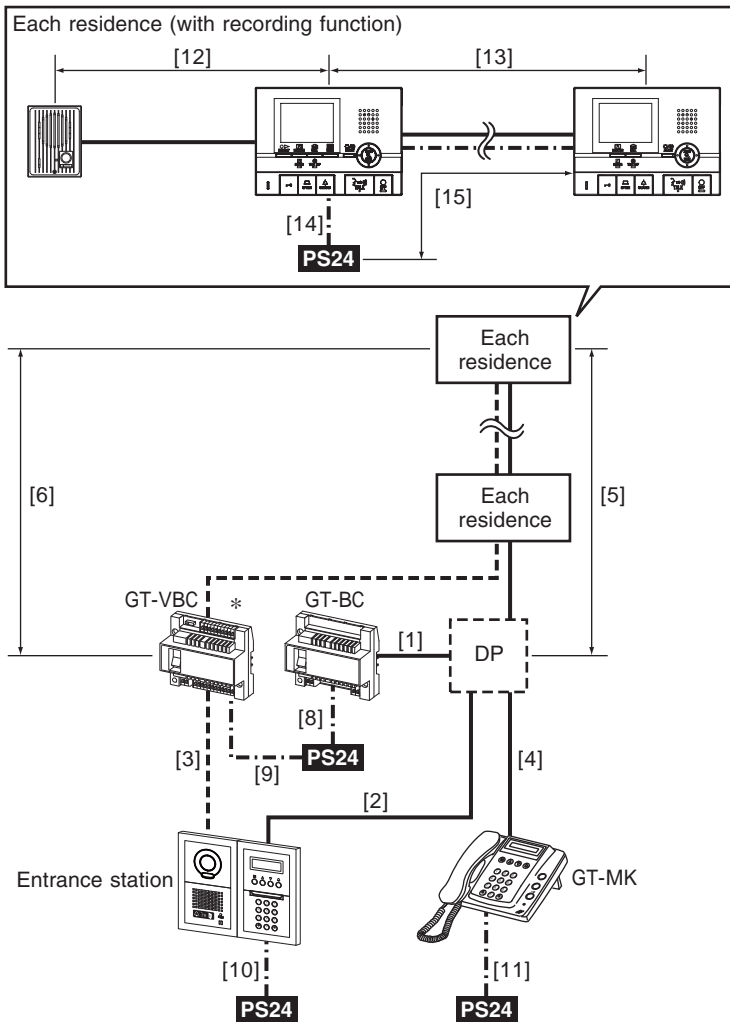

Expanded system

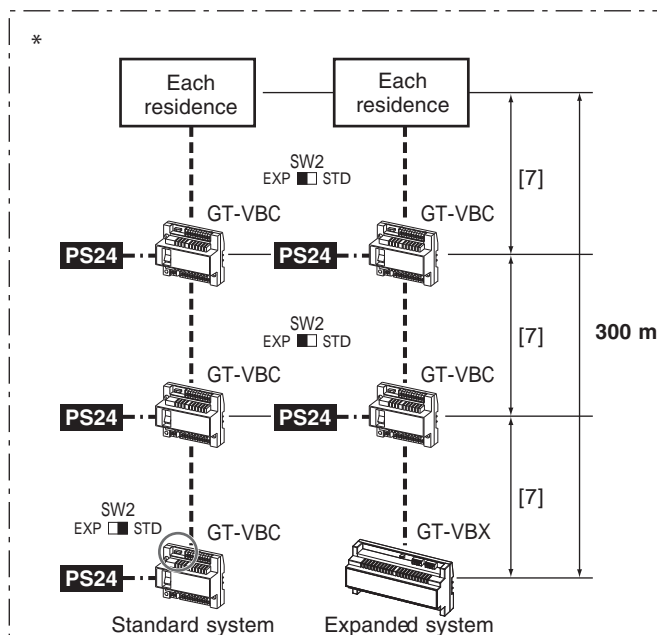
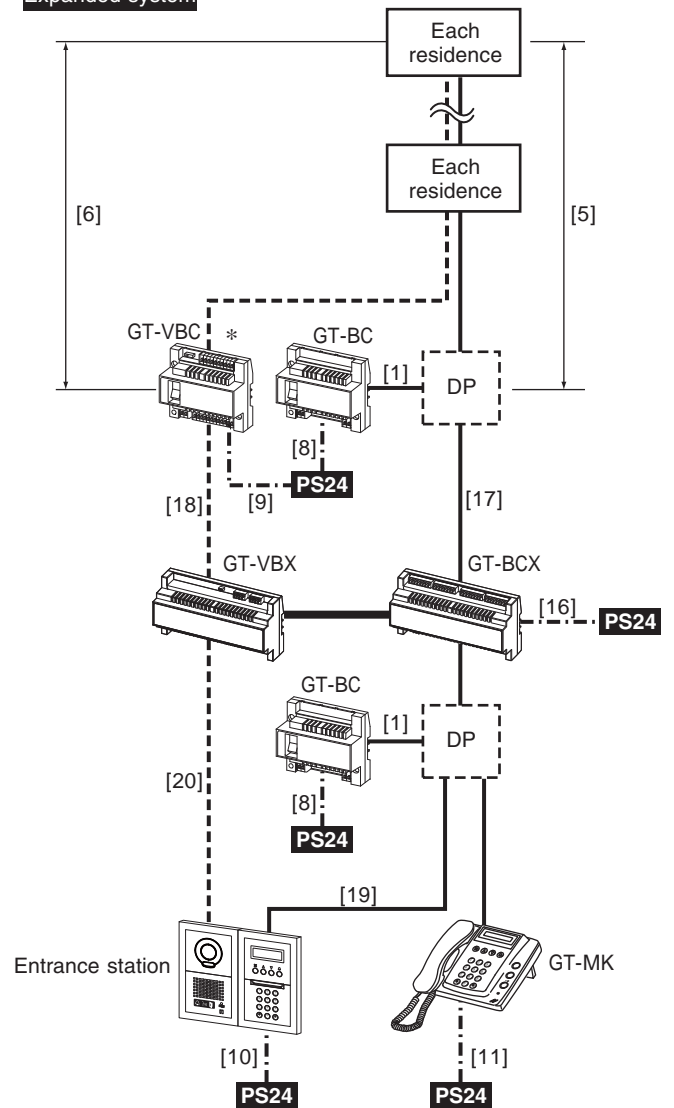

The GT-VBC can be used as an extension adaptor as well (2 units per trunk line). To do so, set the setting switch (SW2) to "EXP". Use the unit as an extension adaptor in expanded systems. Even if two units are used as extension adaptors (SW2: EXP), the wiring distance to the farthest residential station from the GT-VBC (SW2: STD) or GT-VBX is limited to 300 m.

Wiring distance		Wire diameter	0.65 mm (22 AWG)	0.8 mm (20 AWG)	1.0 mm (18 AWG)
[1]	GT-BC - DP *2		3 m (10')	5 m (16')	5 m (16')
[2]	Entrance station - DP *2		150 m (490')	300 m (980')	300 m (980')
[3]	Entrance station - GT-VBC		150 m (490')	300 m (980')	300 m (980')
[4]	GT-MK - DP *2		150 m (490')	300 m (980')	300 m (980')
[5]	DP *2 - farthest residential station (includes system with GT-4Z)		150 m (490')	300 m (980')	300 m (980')
[6]	GT-VBC - farthest residential station (includes system with GT-4Z)		100 m (330')	150 m (490')	150 m (490')
[7]	GT-VBC (SW2: STD) - GT-VBC (SW2: EXP)		100 m (330')	150 m (490')	150 m (490')
[8]	GT-BC - power supply		3 m (10')	5 m (16')	5 m (16')
[9]	GT-VBC - power supply		3 m (10')	5 m (16')	5 m (16')
[10]	Entrance station - power supply		150 m (490')	300 m (980')	300 m (980')
[11]	GT-MK - power supply		150 m (490')	300 m (980')	300 m (980')
[12]	Door station - GT-2C-L, GT-2C		50 m (165')	100 m (330')	100 m (330')
[13]	GT-2C-L, GT-2C - farthest GT-2H-L, GT-2H		50 m (165')	100 m (330')	100 m (330')
[14]	GT-2C-L/GT-2C - power supply		25 m (82')	50 m (165')	75 m (245')
[15]	GT-2H-L, GT-2H - power supply		50 m (165')	100 m (330')	150 m (490')
[16]	GT-BCX - power supply		3 m (10')	5 m (16')	5 m (16')
[17]	GT-BCX - GT-BC		150 m (490')	300 m (980')	300 m (980')
[18]	GT-VBX - GT-VBC (SW2: EXP)		100 m (330')	150 m (490')	150 m (490')
[19]	Entrance station - GT-BCX		150 m (490')	300 m (980')	300 m (980')
[20]	Entrance station - GT-VBX		150 m (490')	300 m (980')	300 m (980')
	GT-NS-V, GT-DMV - (VIGIK)		5 m (16')	10 m (33')	10 m (33')
	Standard system total wiring distance *1		1650m (5400')	2500m (8200')	2500m (8200')
	Expanded system Total wiring distance per common line (maximum 2 trunk lines)		1650 m (5400')	2500 m (8200')	2500 m (8200')
	Expanded system Total wiring distance per sub trunk line (maximum 4 trunk lines)		1650 m (5400')	2500 m (8200')	2500 m (8200')
	GT-RY - transfer source unit		5 m (16')	10 m (33')	10 m (33')
	GT-2C-L, GT-2C - external monitor		1.5 m (5')	3 m (10')	3 m (10')
	Entrance station - surveillance camera		Coaxial cable 15 m (50')		

*1 The track lengths from a door station to a GT-2C-L or GT-2C and from a GT-2C-L or GT-2C to a door station are not included in the total wiring distance.

*2 DP = Distribution Point

2 COMPONENTS

2-1 Entrance Station (Unit type)

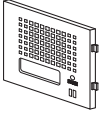
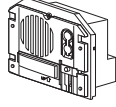
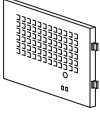
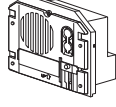
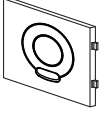
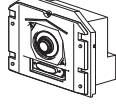
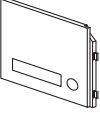
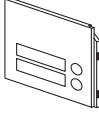
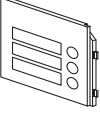
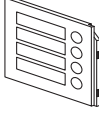
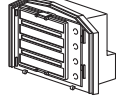
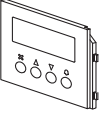
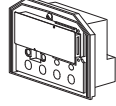
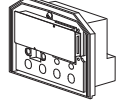
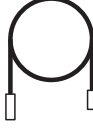
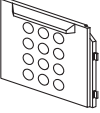
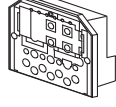
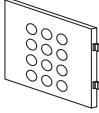
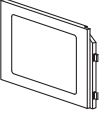
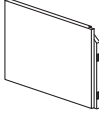
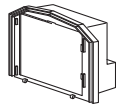
Panel	Module
 <p>Speech module panel (guidance-enabled type) GT-DP-L</p>	 <p>Speech module (guidance-enabled type) GT-DA-L (connector included)</p>
 <p>Speech module panel GT-DP</p>	 <p>Speech module GT-DA (connector included)</p>
 <p>Camera module panel GT-VP</p>	 <p>Camera module GT-VA (connector included)</p>
<div style="display: flex; flex-wrap: wrap;"> <div style="width: 50%;">  <p>1-call button panel GF-1P</p> </div> <div style="width: 50%;">  <p>2-call button panel GF-2P</p> </div> <div style="width: 50%;">  <p>3-call button panel GF-3P</p> </div> <div style="width: 50%;">  <p>4-call button panel GF-4P</p> </div> </div>	 <p>Switch module GT-SW (connector, name card included)</p>
 <p>Name scrolling module panel GT-NSP-L</p>	 <p>Name scrolling module (VIGIK-linked type) GT-NS-V (connector included)</p>
	 <p>Name scrolling module GT-NS</p>
	 <p>USB cable A-B type (1 m) (GT-NS-V, GT-NS included)</p>
 <p>10 key module panel GF-10KP</p>	 <p>10 key module GT-10K</p>
 <p>Access control keypad module with panel GT-AC</p>	
<div style="display: flex;"> <div style="width: 50%;">  <p>Address module panel GF-AP</p> </div> <div style="width: 50%;">  <p>Blank panel GF-BP</p> </div> </div>	 <p>Address module GT-AD (address card, address cover included)</p>

Mounting parts

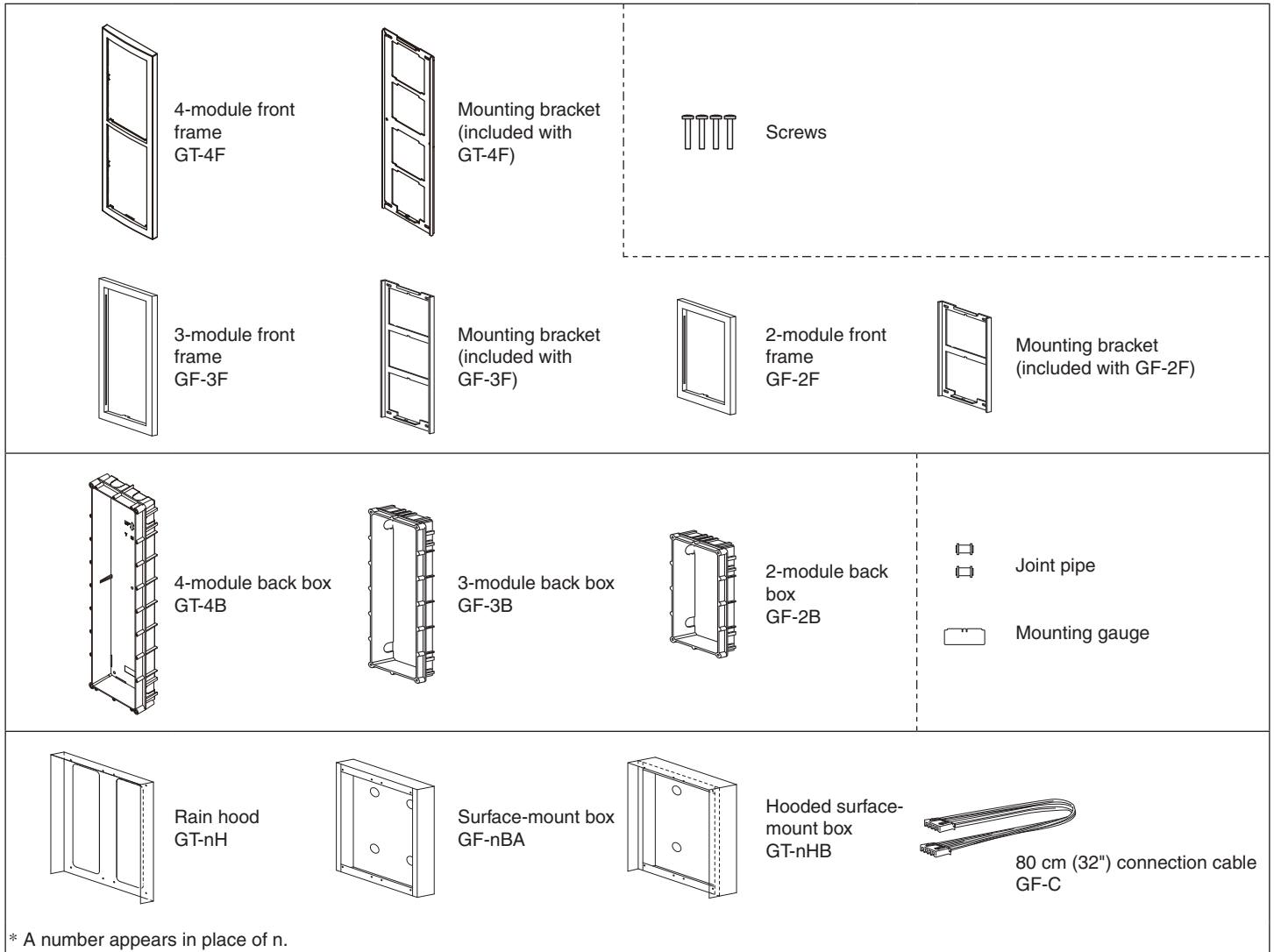

Combination examples

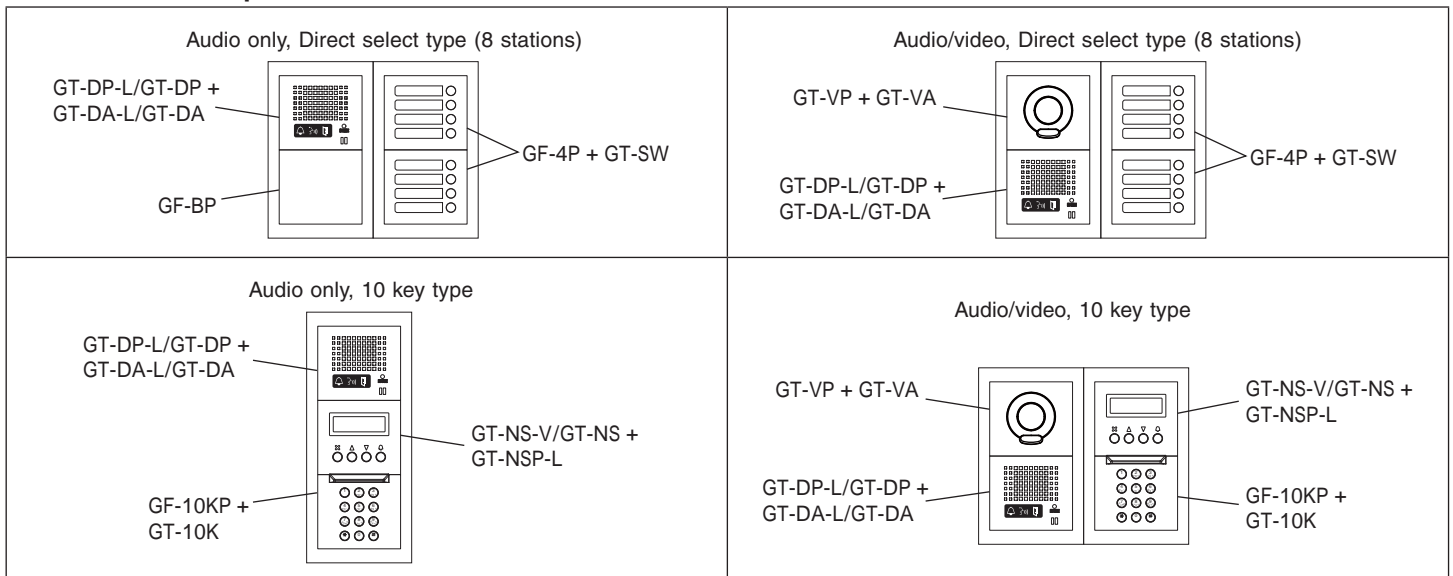

2-2 Entrance Station (Integrated type)

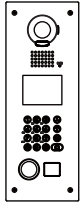

Flush mount entrance station (name scrolling, guidance-enabled, VIGIK-linked type)
GT-DMV
Flush mount entrance station (name scrolling, guidance-enabled)
GT-DM

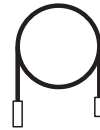

USB cable A-B type (1 m)



Screws



Special screwdriver

2-3 Bus control unit etc.

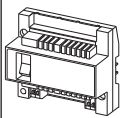

Bus control unit
GT-BC



Special
screwdriver

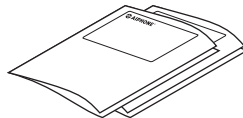

English, French
installation manual



CD

- Installation manual
- Entrance station + security guard station operation manual
- GT-2C (-L) GT-2H (-L) operation manual
- GT-1C (-L) operation manual
- GT-1M-L operation manual
- GT-1D operation manual
- Setup tool

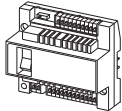

Video bus control unit
GT-VBC

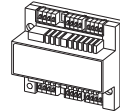

4-way video junction unit
GT-4Z

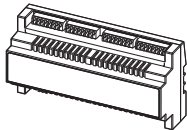

Expanded bus control unit
GT-BCX
(mounting bracket included)

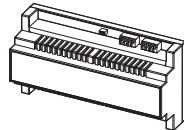

Expanded video bus control unit
GT-VBX
(mounting bracket included)

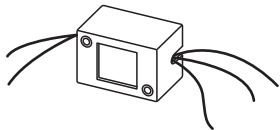

External
signaling relay
GT-RY



Wood mounting
screws

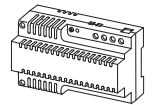

Power supply
PS-2420DIN

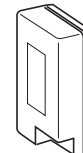

Power supply
PS-2420, PS-2420S,
PS-2420UL

2-4 Residential station

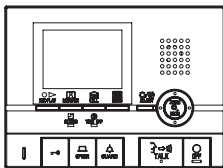

Master monitor station
(with recording function,
hearing aid-compatible)
GT-2C-L

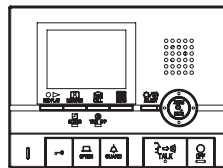

Master monitor station
(with recording function)
GT-2C



Wood mounting screws



Screws

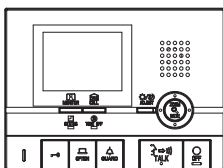

Sub master monitor
station (hearing aid-
compatible)
GT-2H-L

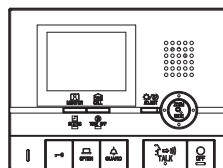

Sub master monitor
station
GT-2H

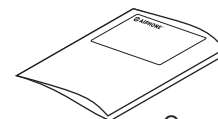

Operation manual
(GT-2C-L, GT-2C only)

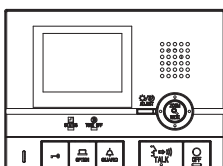



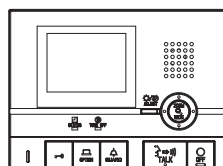



Residential monitor
station (hearing aid-
compatible)
GT-1C-L

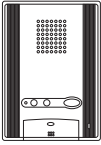

Residential monitor
station
GT-1C



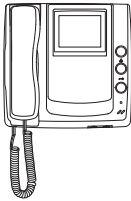

Option connector
(not included with
GT-2H-L, GT-2H)





 <p>Residential station GT-1A</p>	 Wood mounting screws	 <p>Optional handset GT-HS</p>
 <p>Residential station GT-1D</p>	 Screws	
 <p>Residential monitor station with handset GT-1M-L</p>	 <p>Option connector</p>	

2-5 Door station

For door stations other than the GT-D, see the instruction manual for that door station.

 <p>Door station GT-D</p>	 Wood mounting screws  Screws
--	--

2-6 Security guard station

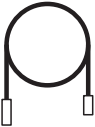
 <p>Security guard station GT-MK</p>	 <p>Option connector</p>	 Wood mounting screws  Screws	 <p>USB cable A-B type (1 m)</p>
---	---	--	---

3 MOUNTING

3-1 Mounting locations

- For video entrance stations and video door stations, the picture quality of residential station monitoring is affected by the nature of the external light from above and the surrounding area of the built-in cameras, so do not install these stations in the types of locations shown below.
- Locations exposed to direct sunlight
- Locations under street lights or door lights
- Other locations exposed to strong light

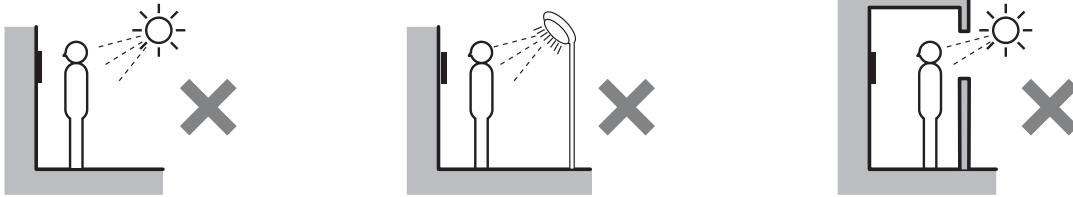

- Install master monitor stations and sub master monitor stations in places where the screen is not exposed to direct sunlight.
- A switch is located on the right side of the GT-2C-L/GT-2C, GT-2H-L/GT-2H, and GT-1C-L/GT-1C. Allow open space of 5 cm (2").
- At least 15 cm (6") of vertical open space from the center of the mounting bracket is needed for mounting the master monitor station or sub master monitor station.
- Entrance stations (Integrated type) include a sensor. Do not place objects such as plants or trees in places monitored by the sensor. Also, placing the unit in bright sunlit areas may prevent the sensor from working properly.

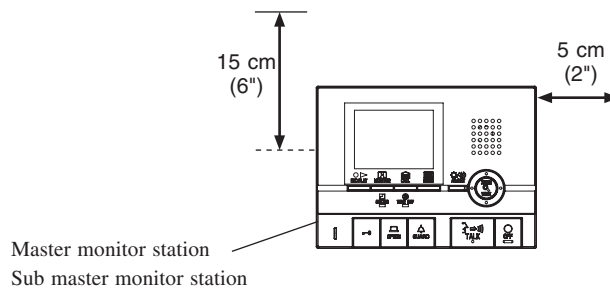
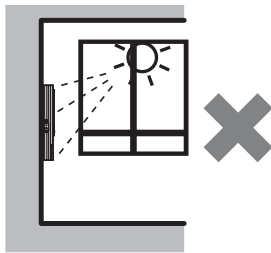

3-2 Appropriate cable

- Use PE (polyethylene)-insulated PVC jacket cable. Parallel or jacketed 2-conductor, mid-capacitance non-shielded cable is recommended.
- Never use individual conductors, twisted pair cable or coaxial cable.

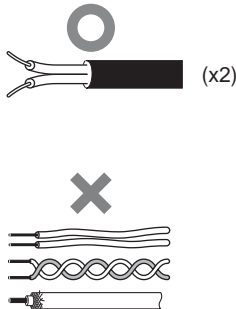

Weak electrical current line connection

Length is 8 mm for the GT-DA-L/GT-DA, GT-DMV/GT-DM, GT-2C-L/GT-2C, GT-2H-L/GT-2H, GT-1C-L/GT-1C, GT-BCX, GT-VBX, and GTW-LC; and 9 mm for other units.



Insert the wire into the direct terminal. If it is difficult to insert the wire, insert it while pressing the release button.

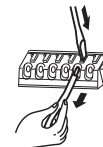
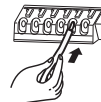

3-3 Mounting positions and image view area

⚠ When using the camera module, if the rain hood is attached a portion of it will show up in the camera display.

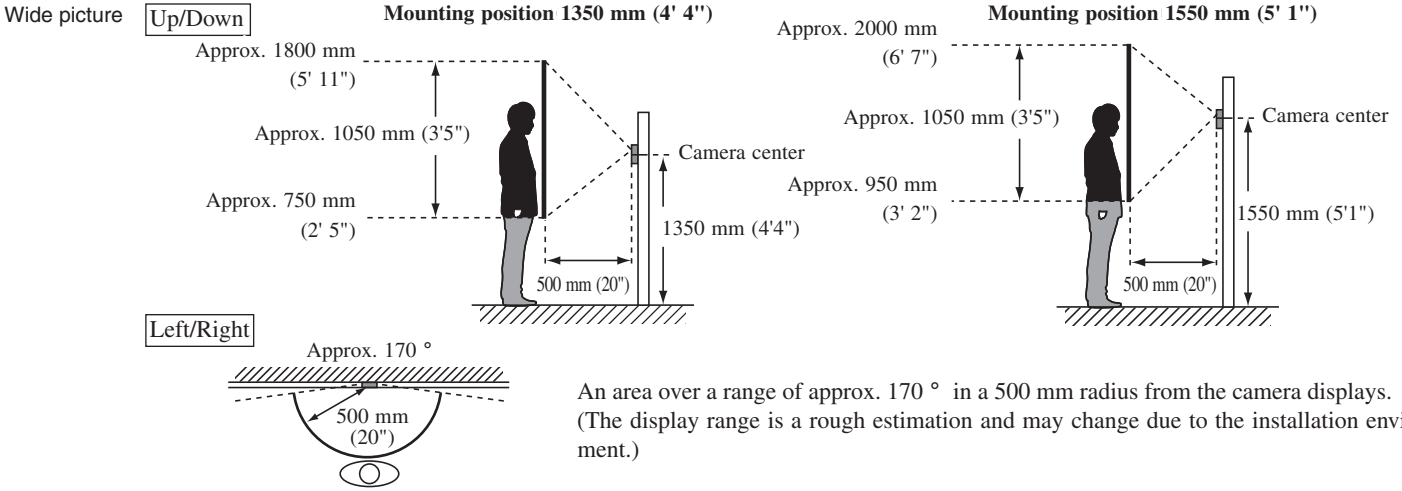

Zoom picture Up/Down (with mounting position of 1350 mm (4' 4"))

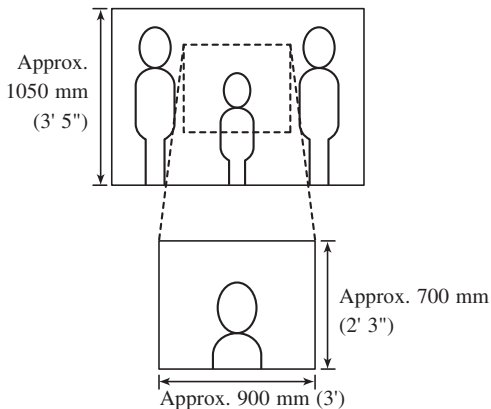
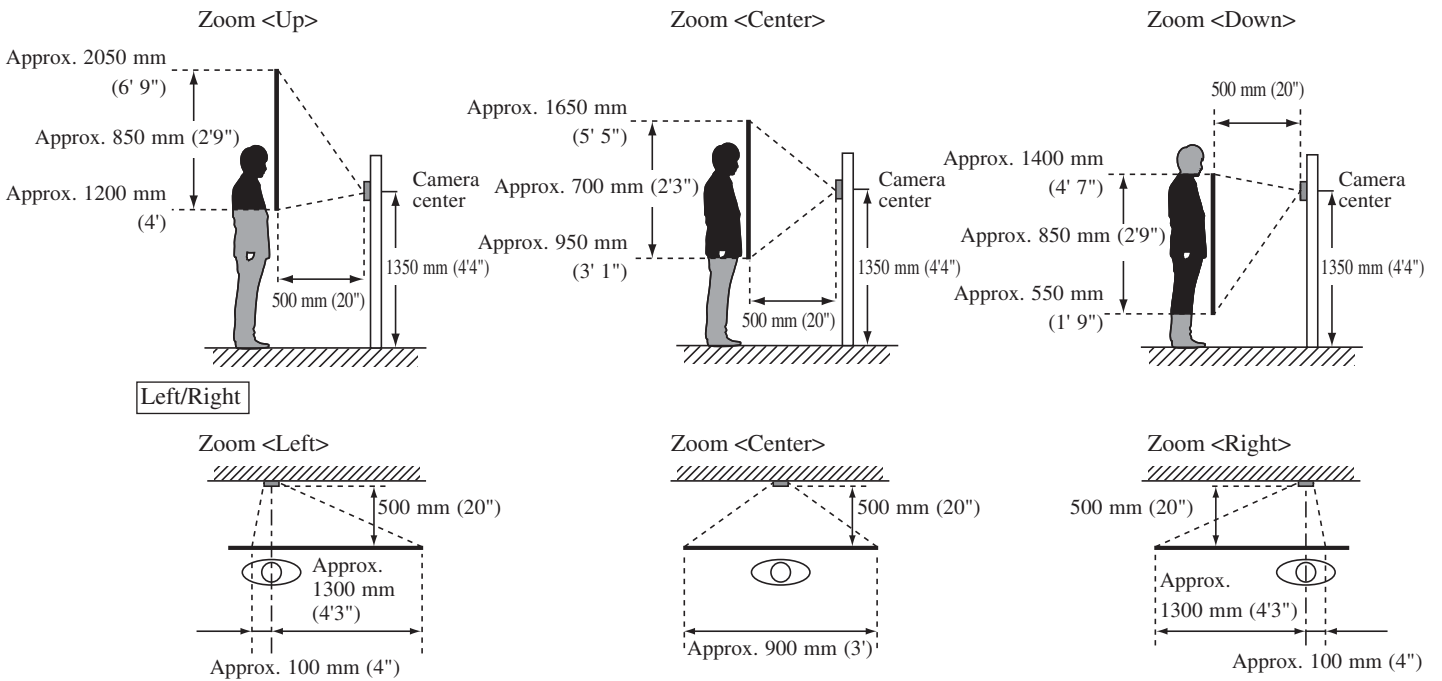

Objects appear smaller due to greater distortion in the surrounding sections compared to the central section, but a wider area is displayed. The display range is a rough estimation and may change due to the installation environment.

The zoom position can be changed. At the time of shipment, the zoom position is set at "Zoom central".

3-4 Entrance Station (Unit type)

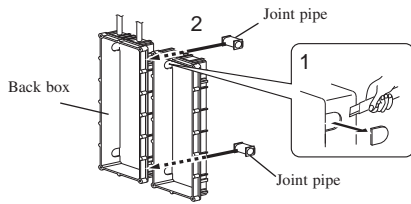

- 1** Make a hole for the cable.
- 2** Use the joint pipe to assemble the back box.
 - Make sure the back box is mounted level.

Back box assembly dimensions

Back box GF-2B

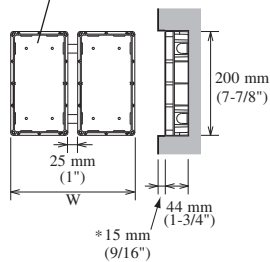

Back box GF-3B

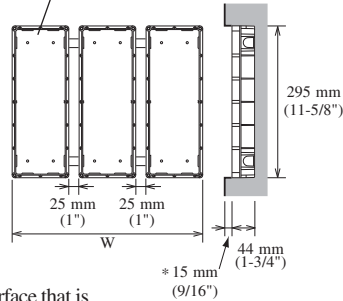

Back box GT-4B

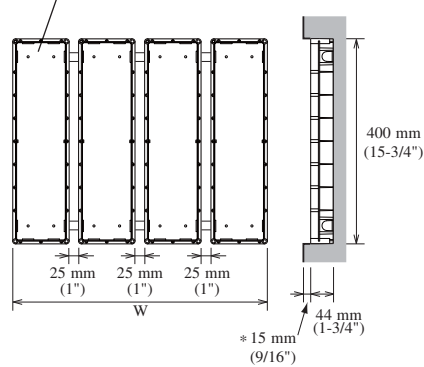

GF-2B/3B GT-4B	W (mm)	W (inch)
x 1	110	4-5/16"
x 2	245	9-5/8"
x 3	380	15"
x 4	515	20-1/4"
x 5	650	25-9/16"
x 6	785	30-7/8"
x 7	920	36-1/4"
x 8	1055	41-9/16"
x 9	1190	46-7/8"

* Do not mount the back box on a surface that is recessed by 15 mm (1/2") or more from the external surface of the wall.

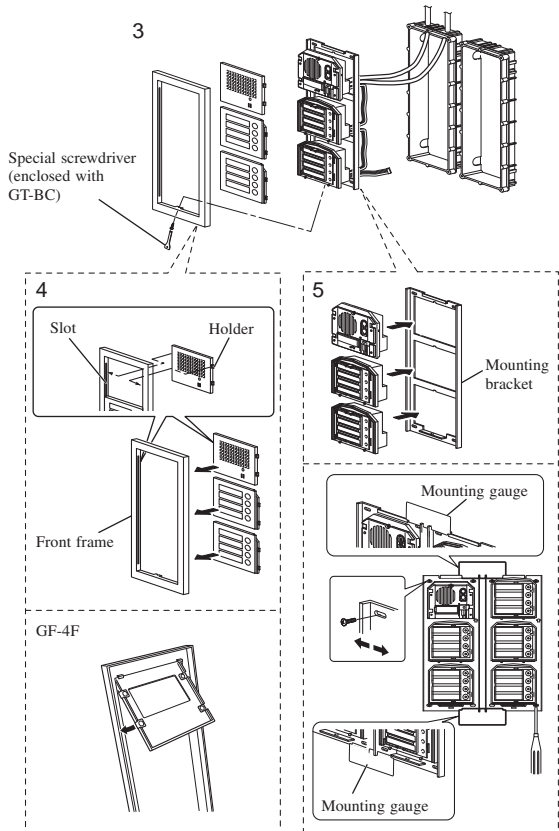

- 3** Assemble the module.
 - For the useable modules, see 2-1.
 - The GT-SW can have up to 6 modules.

To connect 7 or more modules or to increase the light intensity, please contact Aiphone.

- 4** Mount each module panel to the front frame.
 - Mount the panels from behind the front frame.
 - Insert the holders into the slots on both sides.

(With the GT-4F, mount the module panels so that they catch on the tabs in order from top to bottom.)

- 5** Mount each module, except the GT-AC, to the mounting bracket.
 - Set the modules in the mounting bracket until they click in place.
 - To mount multiple rows of modules, apply the mounting gauge to the mounting bracket.

While using the mounting gauge to make adjustments, tighten the screws. (A mounting gauge is included with the GF-2B, GF-3B, and GT-4B built-in back box.)

Options

Rain hood GT-203H

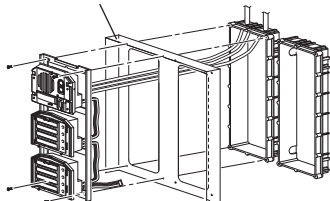

Hooded surface-mount box GT-203HB

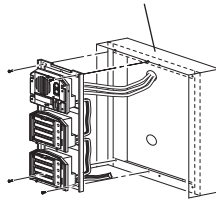

Surface-mount box GF-203BA

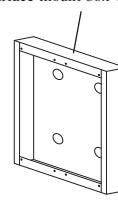

80 cm (32") connection cable GF-C



6 GT-DA-L/GT-DA

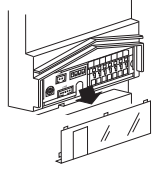

6 Remove the terminal cover.

7

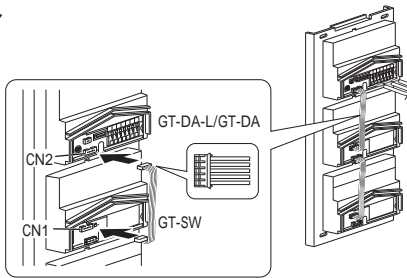

7 From the speech module to the next module, insert the attached connector into the socket.

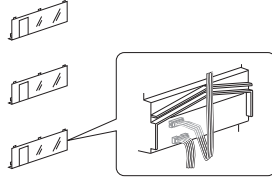

Make sure to run the cable under the terminal cover for protection.

8

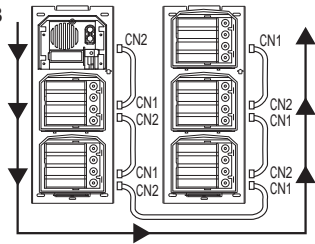

8 Connect the connectors between the modules with cables.

Mount modules on the back boxes.

Example of interconnection of modules

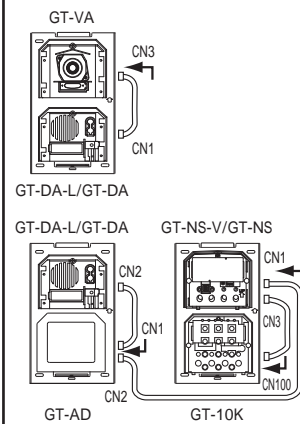

Use the GF-C to connect to the name scrolling module. To position the speech module in the center row, run the GF-C through the joint pipe in advance.

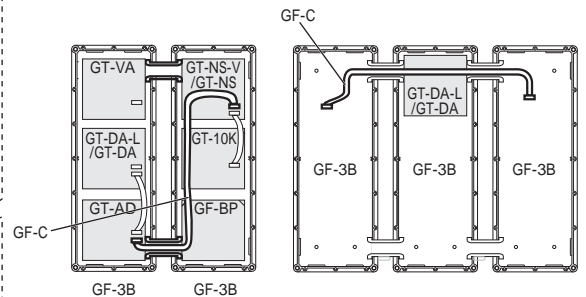

9

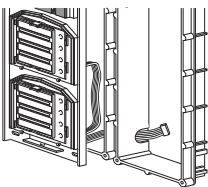

9 Run the connection cable through the joint pipe (which you should have made open in advance) and connect CN1 of the GT-SW to the next row.

10

GT-DA-L/GT-DA

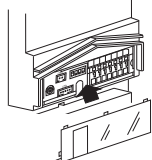

10 Put back the terminal cover.

Mount the front frame and tighten with the special screwdriver (enclosed with GT-BC).

11

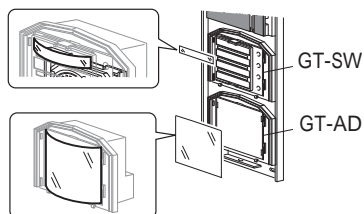

11 For the GT-SW and GT-AD, remove the resident name/address plate or paper by pressing either the left or right end. (Peel off the plastic film.)

Use a permanent pen to write the resident name and address on the transparent plate and mount the plate on the module.

3-5 Entrance Station (Integrated type)

GT-DMV
GT-DM

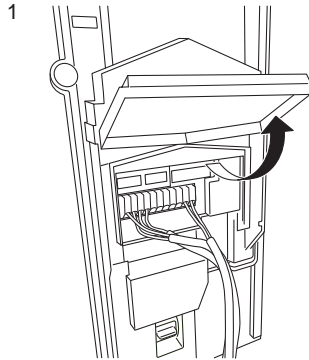

1 Open the cover and connect the wiring to the terminal block.

Insert the wire into the direct terminal. If it is difficult to insert the wire, insert it while pressing the release button.

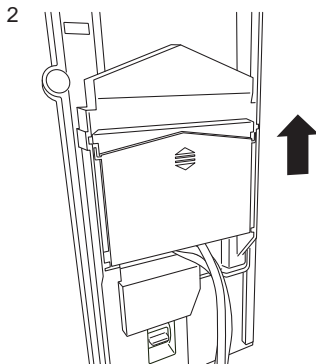
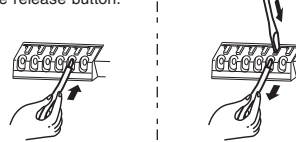

2 Close the cover until it clicks into place.

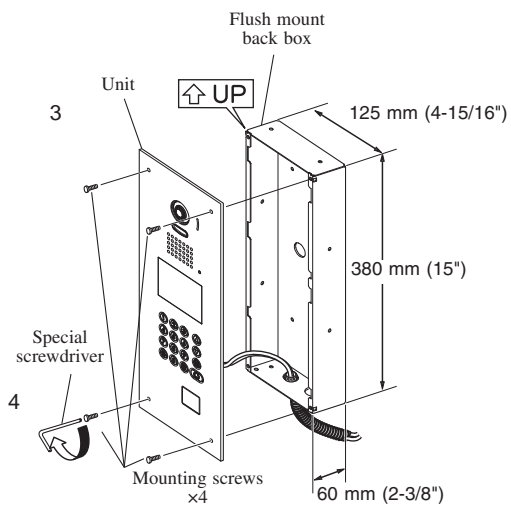

3 Mount the unit in the flush mount back box.

4 Tighten the locking screws using the special screwdriver.

3-6 Bus control unit, 4-way video junction unit and power supply

DIN rail mounting

⚠ The length of the connecting cable between the GT-BCX and GT-VBX is 40 cm. Therefore, mount them adjacently to each other.

1 Mount the unit on the DIN rail. Click the unit into place.

2 When removing the unit, pull the lock release lever down.

* When the system does not operate properly, check the wiring.

Turn off the GT-BC and GT-VBC power switch and then turn the switch back on after four seconds.

This will reset the entire system.

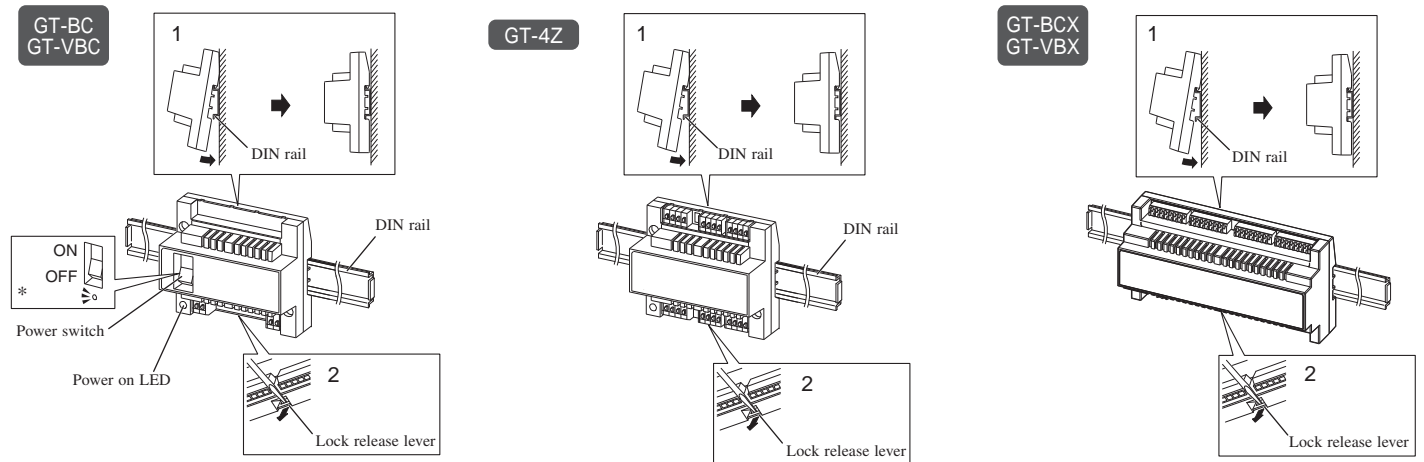

Direct mounting to wall surfaces

Use the wall mounting screws to mount the unit to a wall surface.

⚠ The GT-BCX and GT-VBX cannot be mounted directly to a wall surface.

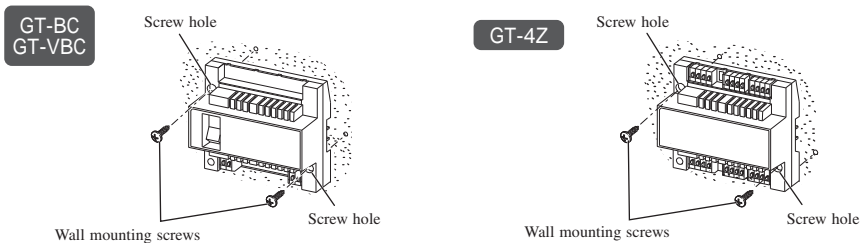

PS-2420DIN

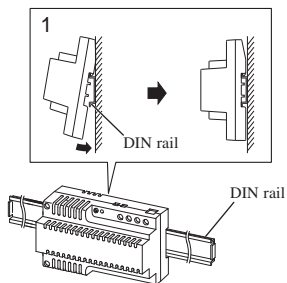

PS-2420
PS-2420S
PS-2420UL

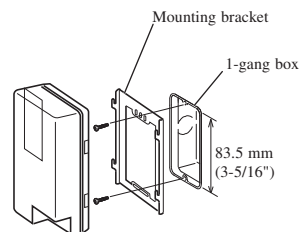

3-7 Residential station

GT-2C-L
GT-2C
GT-2H-L
GT-2H
GT-1C-L
GT-1C

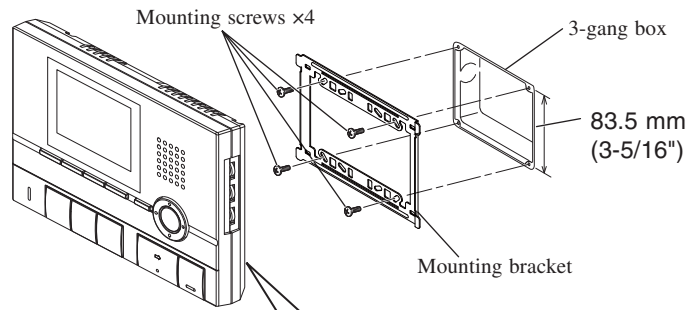

1. Press the release button (to insert or remove the wire).
2. Insert the cable into the terminal.
 - To remove the terminal block, slide the terminal block and pull it out.
 - Strip away the jacket of the cable and insert all wires into the slots in an orderly fashion. Failure to do so could result in pinching that may damage the wiring.

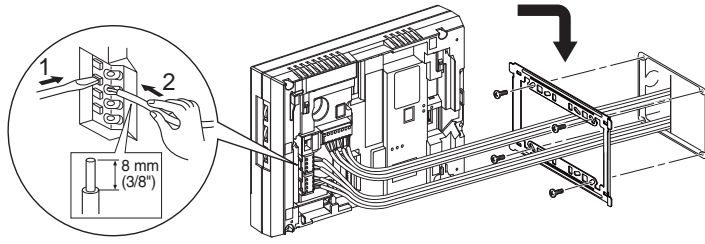

Surface wiring

- * When a 3-gang box is not mounted, the cable can be routed as surface wiring to the top or bottom of the unit.

Cut a cable inlet on the upper part of the unit to allow passage of the wiring into the unit.

If there is a large amount of wiring, strip away the jacket of the cable up to the cable inlet.

- * To pass the cable through the back of the unit, cut out the cable inlet.

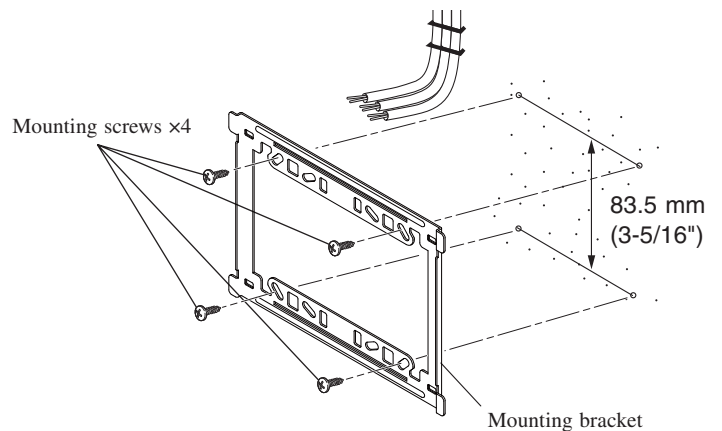
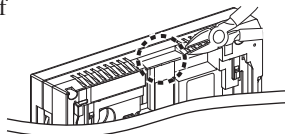

Optional handset

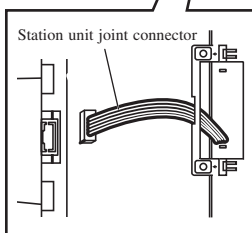
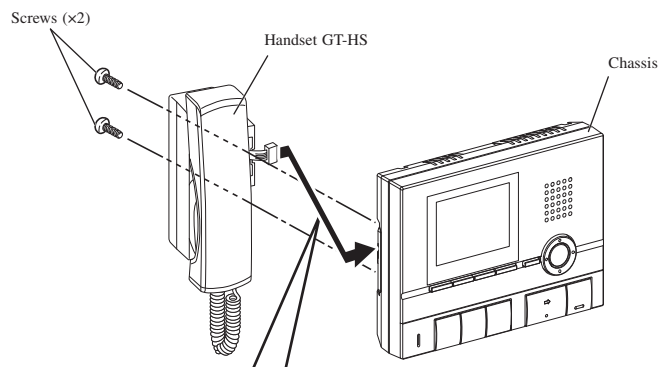

Connect the station unit joint connector.

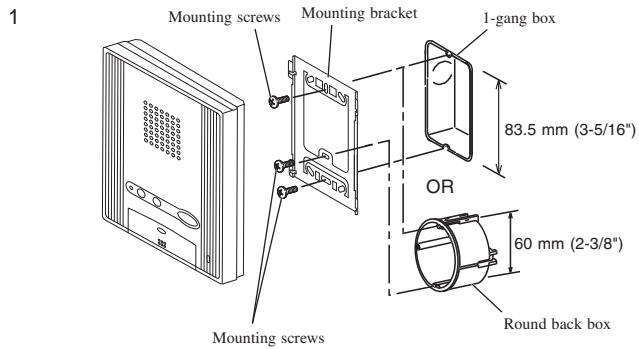

1 Mount the mounting bracket on the 1-gang box or round back box.

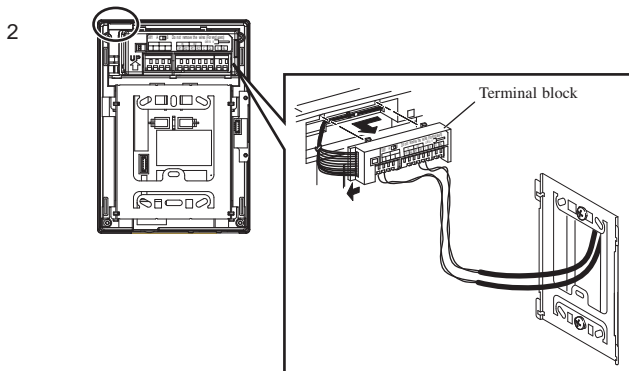

2 Connect the wiring to the terminal block.

- To remove the terminal block, slide the terminal block and pull it out.
- Strip away the jacket of the cable and insert all wires into the slots in an orderly fashion. Failure to do so could result in pinching that may damage the wiring.
- For surface wiring, cut out the cable inlet.

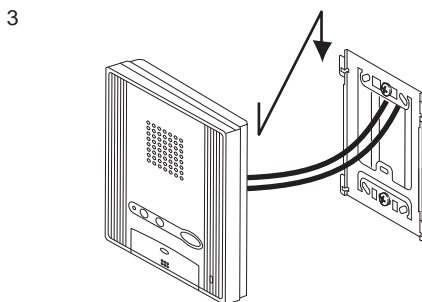

3 Mount the station unit to the mounting bracket.

GT-1D

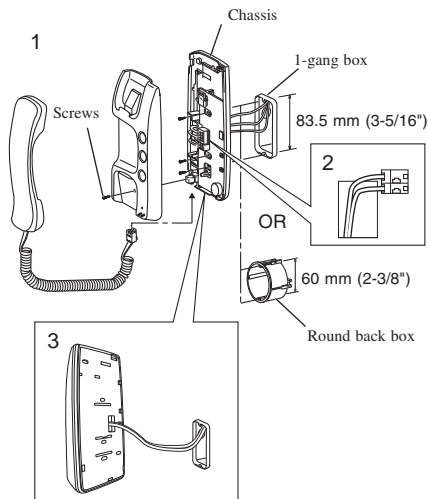

1 Mount the station unit to the chassis or mounting bracket.

2 Connect the wiring to the terminal block.

GT-1M-L:

- To remove the terminal block, slide the terminal block and pull it out.
- Strip away the jacket of the cable and insert all wires into the slots in an orderly fashion. Failure to do so could result in pinching that may damage the wiring.

3 Mount the station unit to the chassis or mounting bracket.

- For surface wiring, cut out the cable inlet.

GT-1M-L

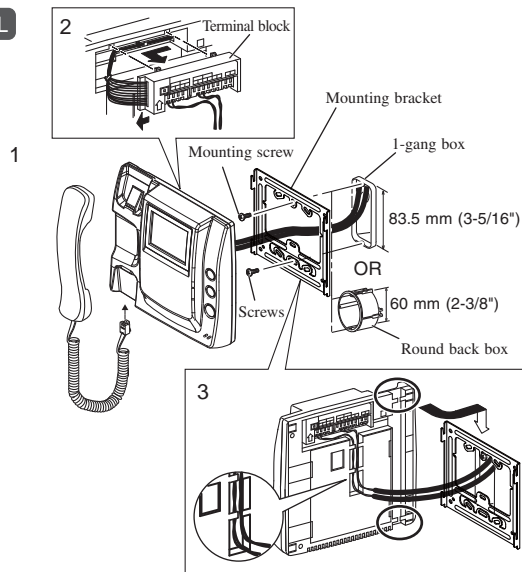

3-8 Door station

For door stations other than the GT-D, see the included instructions.

GT-D

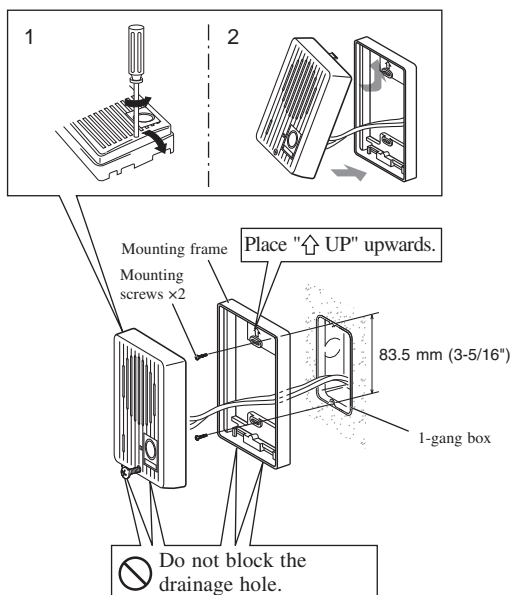

1 Loosen the screws and remove the mounting frame and main unit.

2 After connecting the wiring, mount the main unit to the mounting frame.

- For surface wiring, insert wiring from the cable inlet (lower part).

3-9 Security guard station

GT-MK

⚠ Peel off the protection film on the display.

Desk-top mounting using the GFW-S stand

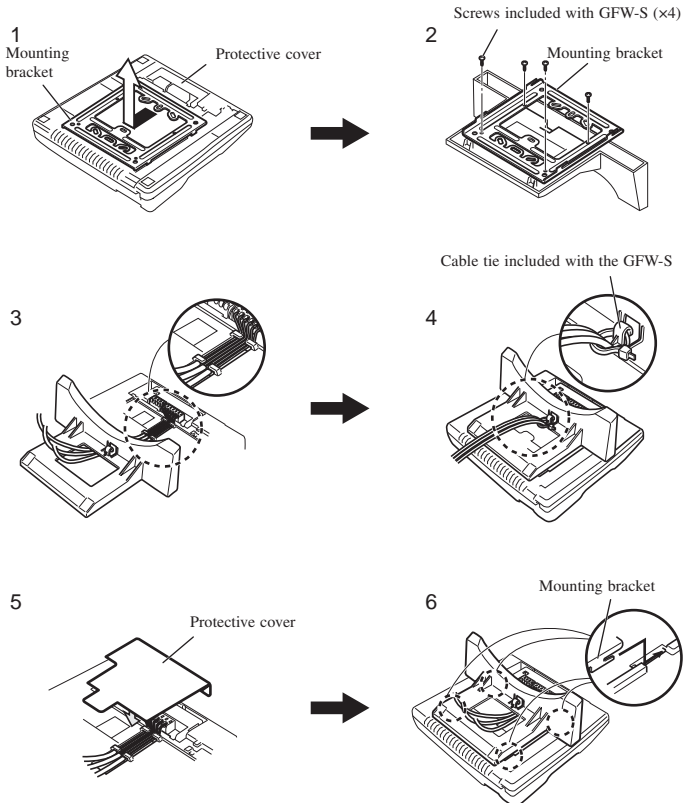

1 Separate the mounting bracket and the protective cover from the back of the unit.

2 Mount the mounting bracket to the GFW-S as shown in the drawing.

3 Strip away the jacket of the cable and insert all wires into the slots in an orderly fashion while connecting them to the terminal block. Failure to do so could result in pinching that may damage the wiring.

4 Set the wiring in place with the cable tie to ensure that they are not pulled out.

5 Cover the terminal section with the protective cover.

6 Insert the mounting bracket latch and slide it upward until it locks.

Wall mounting

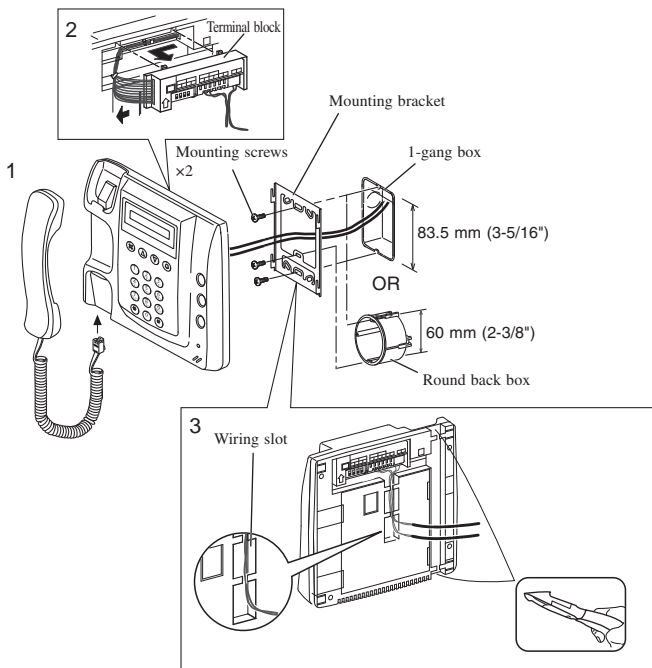

1 Mount the mounting bracket on the 1-gang box or round back box.

2 Connect the wiring to the terminal block.

- To remove the terminal block, slide the terminal block and pull it out.
- Strip away the jacket of the cable and insert all wires into the slots in an orderly fashion while connecting them to the terminal block. Failure to do so could result in pinching that may damage the wiring.

3 Mount the unit to the mounting bracket.

- For surface wiring, cut out the cable inlet.

4 WIRING

4-1 Standard system for common area

⚠ Put each piece of wiring in a separate sheath as shown in the diagram below.

Entrance station

Entrance station #1 to #3
Ex.) Unit type



GT-DA-L/GT-DA
SW2: 2-4

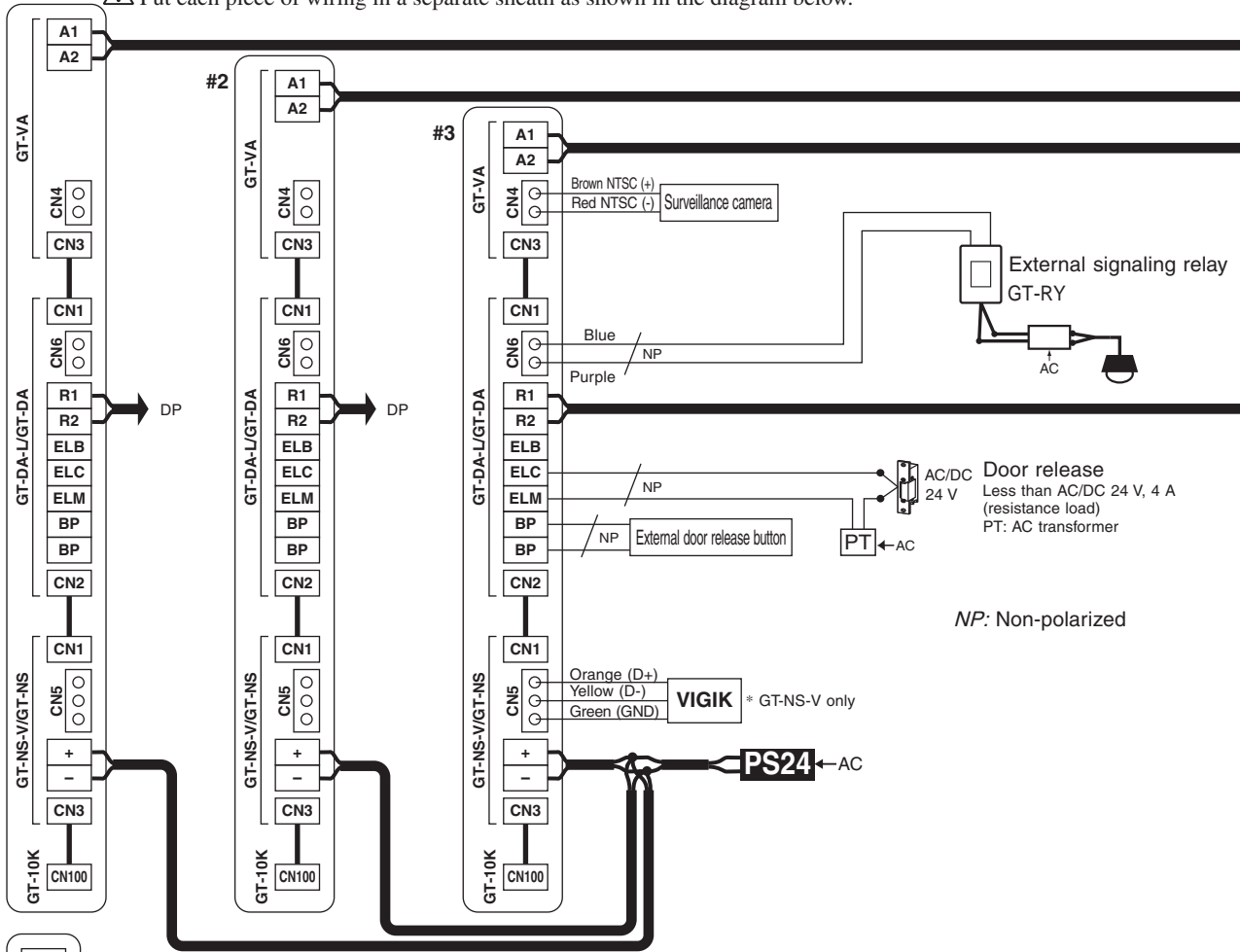
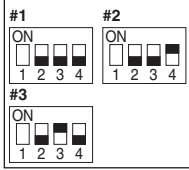

NP: Non-polarized

Entrance station #4 to #5
Ex.) Integrated type

GT-DMV/GT-DM

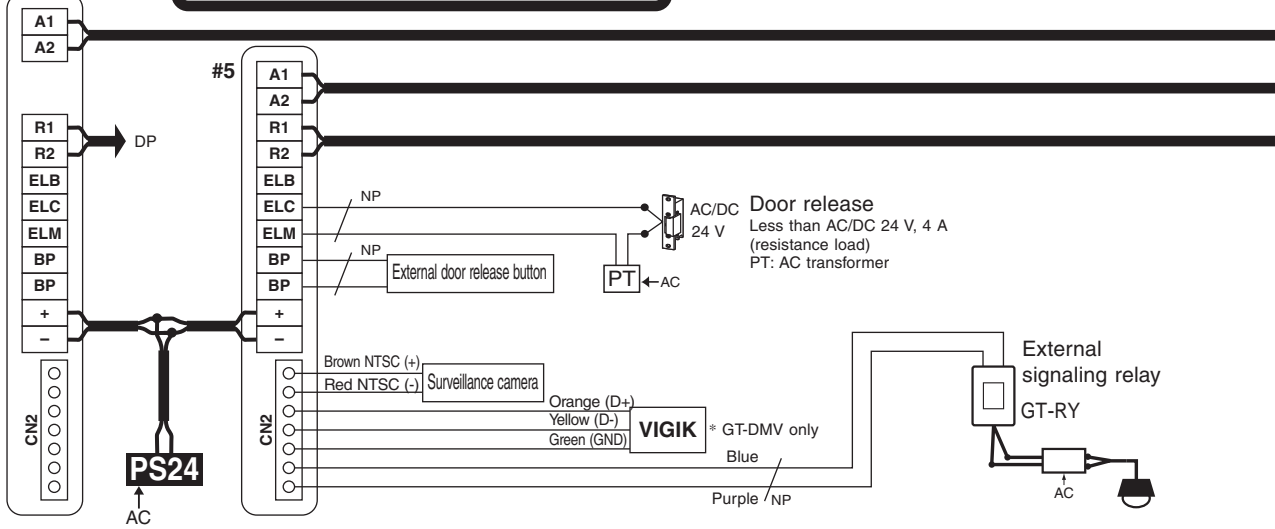
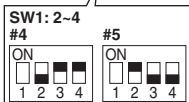
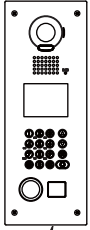

Security guard station

GT-MK

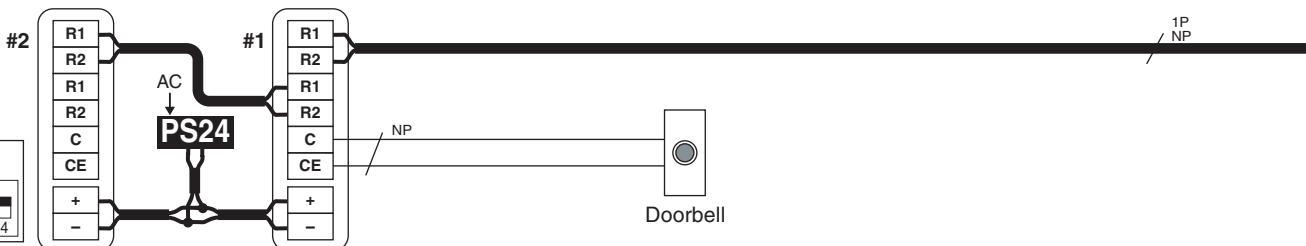
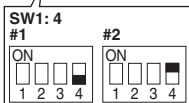

Bus control unit

Video bus control unit GT-VBC

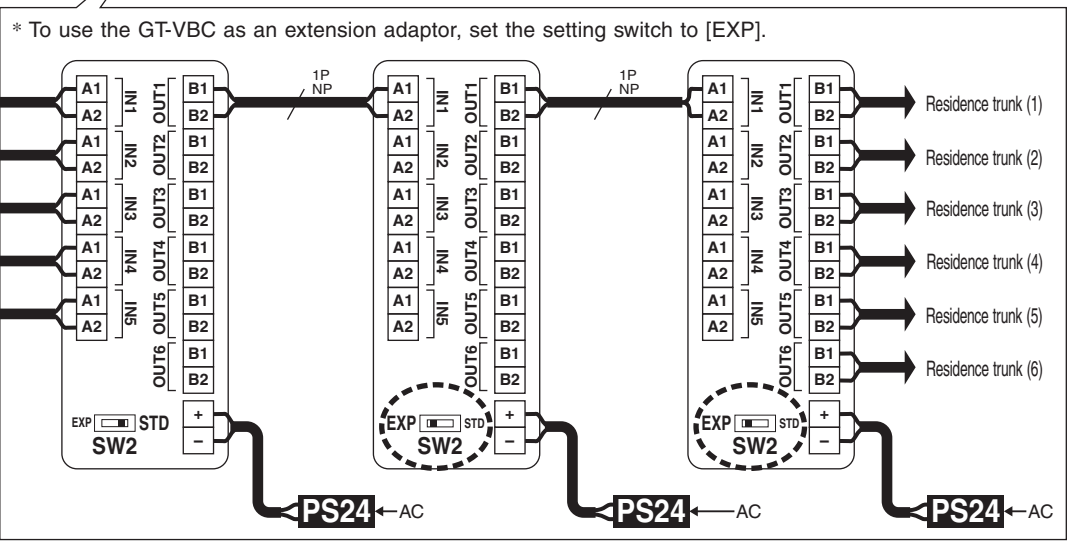
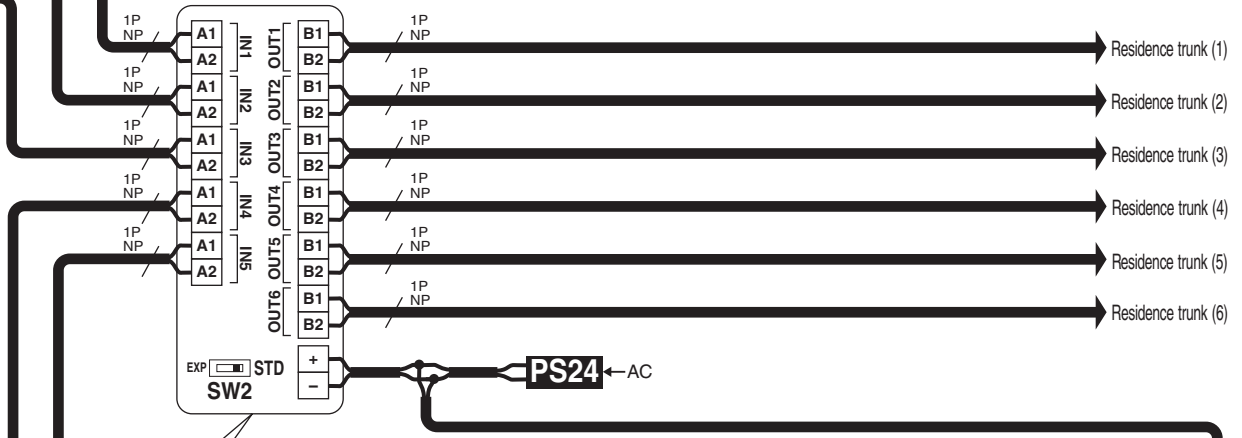
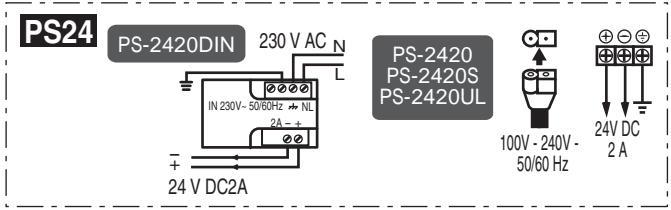
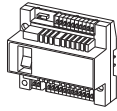

Bus control unit GT-BC

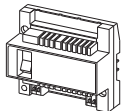

⚠ After all units are connected, make sure to refer to [5 SETTINGS (COMMON AREA)] for setting.

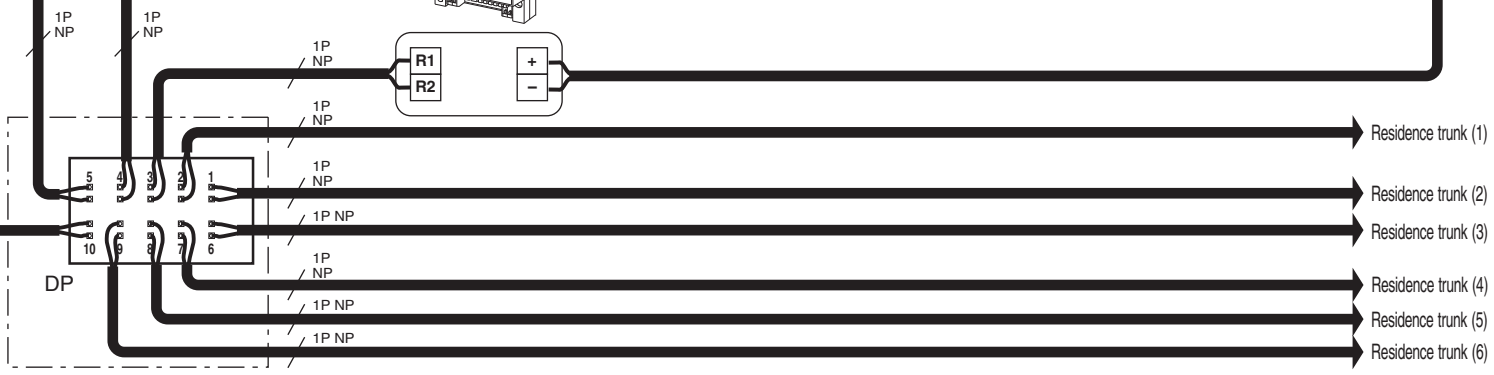

DP = Distribution Point (not included)

4-2 Standard system for residence (station-to-station wiring)

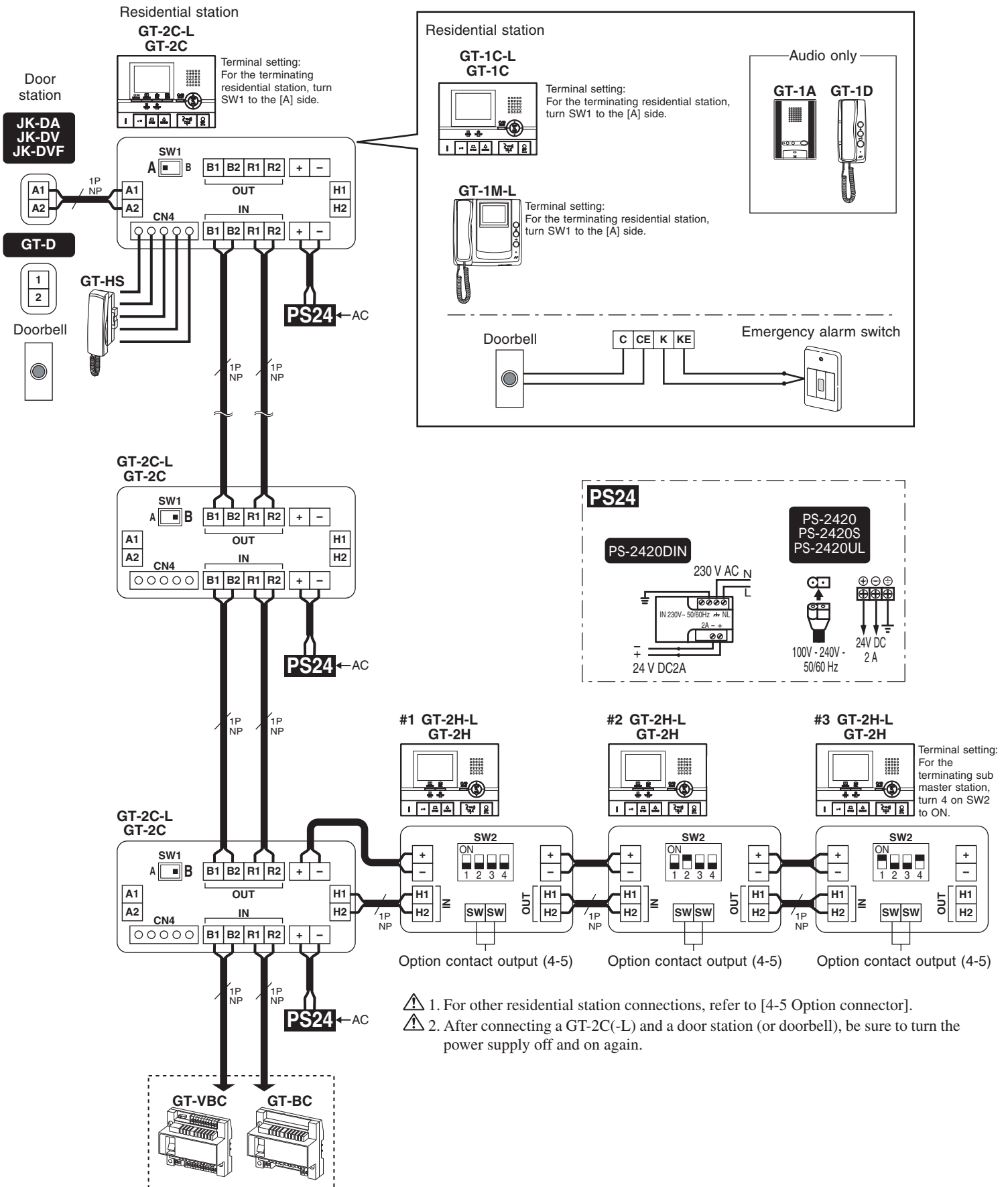

4-3 Standard system for residence (homerun wiring)

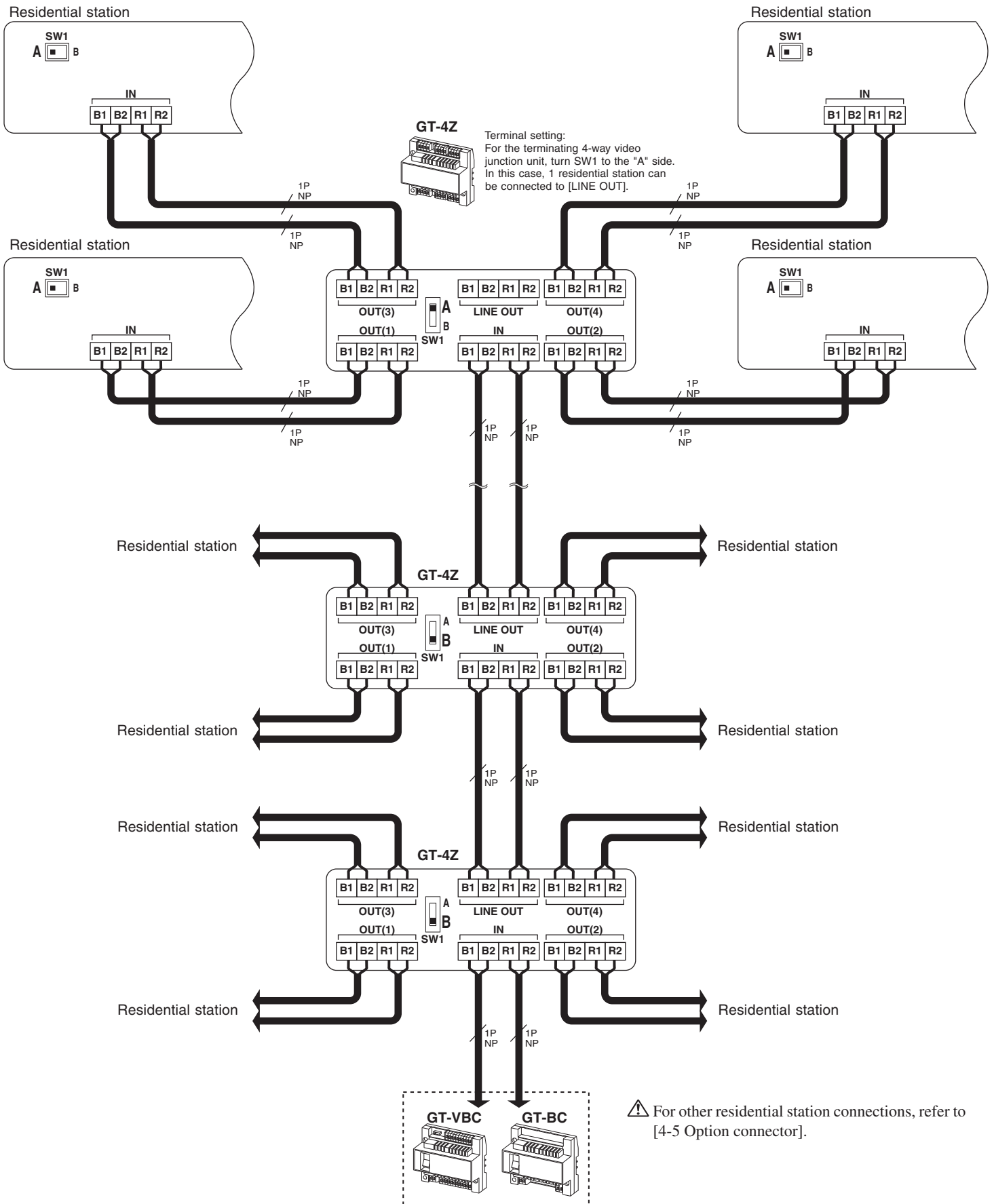

4-4 Expanded system

Common trunk line system (1)

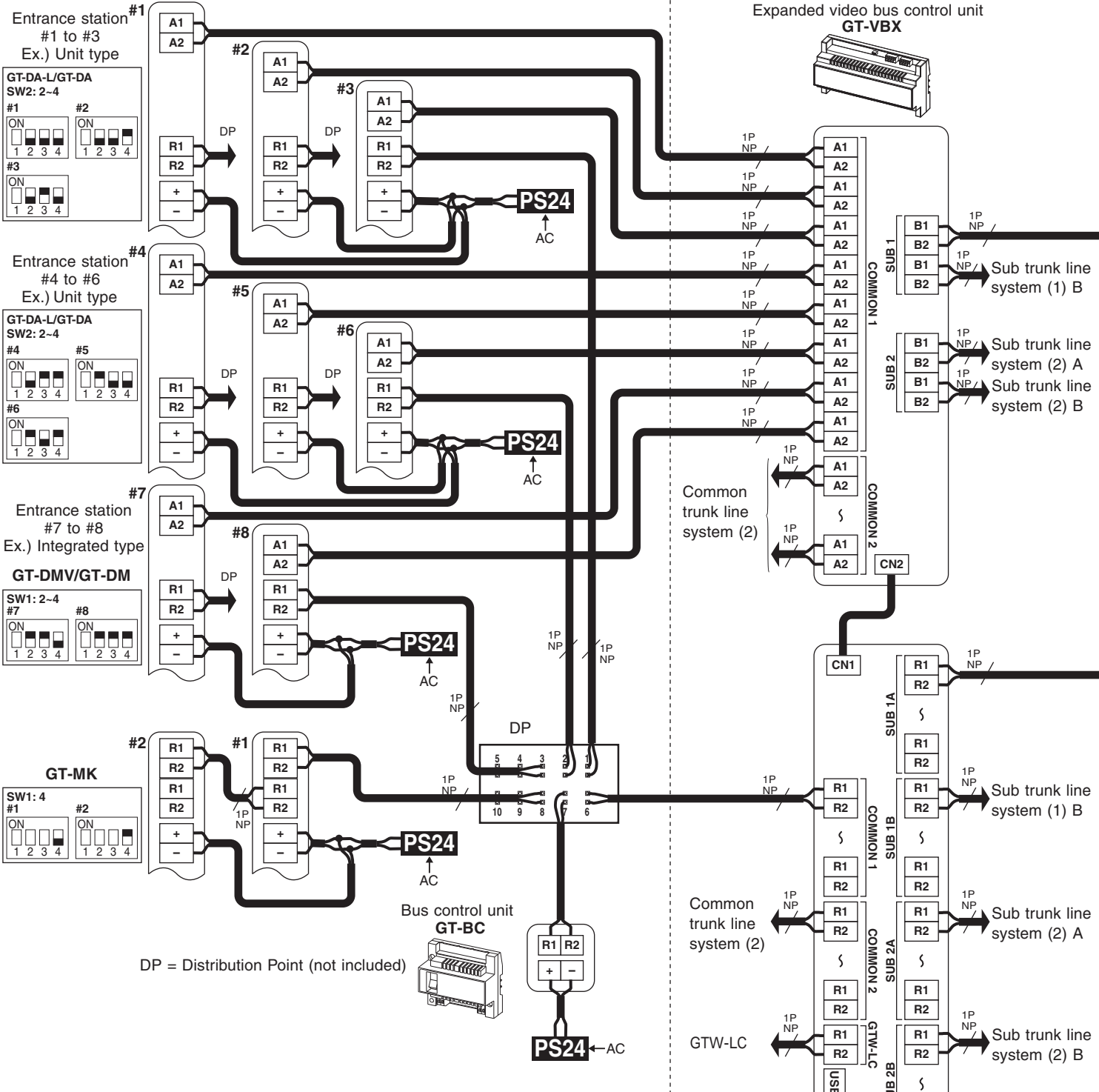

Common trunk line system (2)



⚠ Put each piece of wiring in a separate sheath as shown in the diagram below.

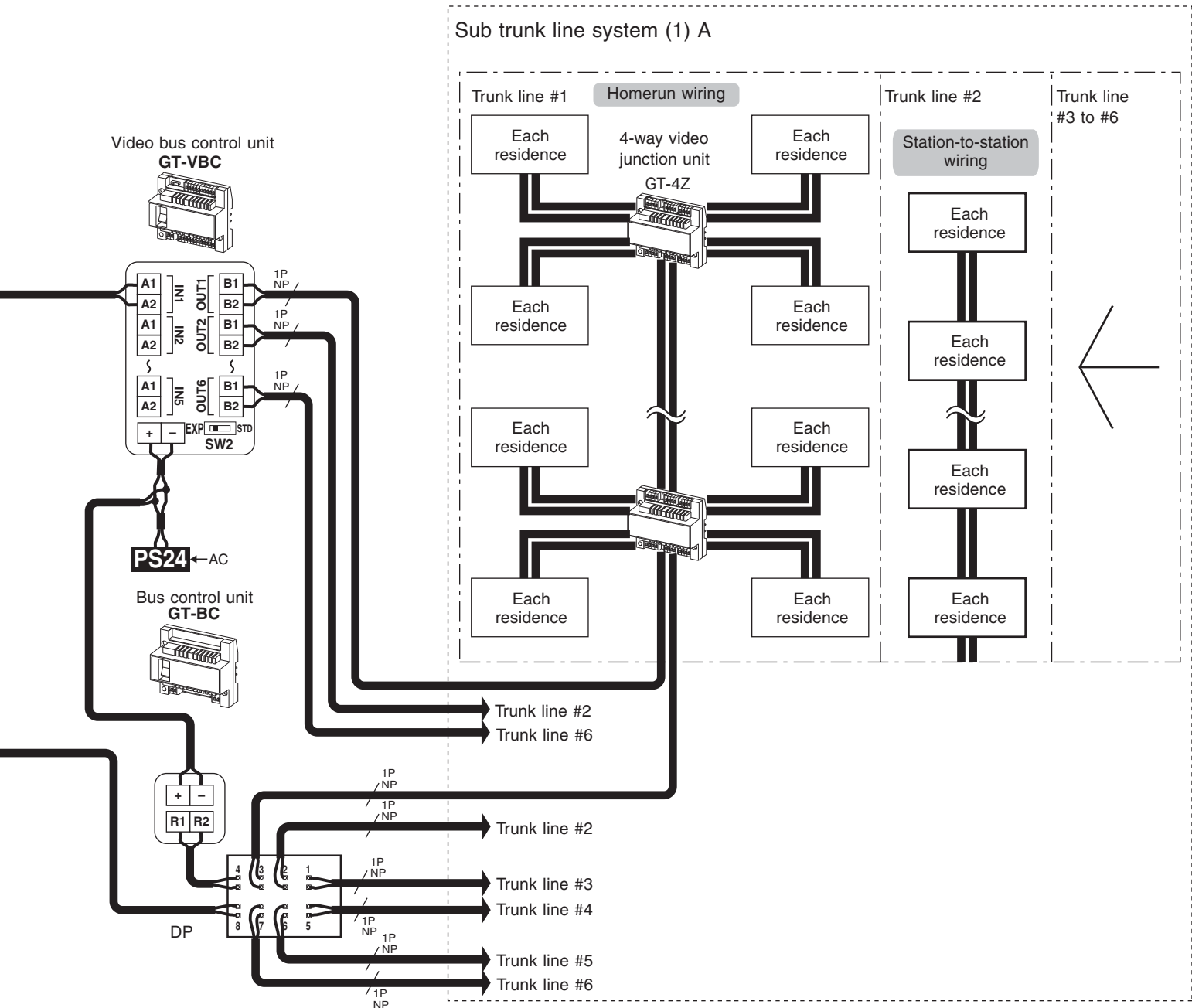

⚠ After all units are connected, make sure to refer to [5 SETTINGS (COMMON AREA)] for setting.

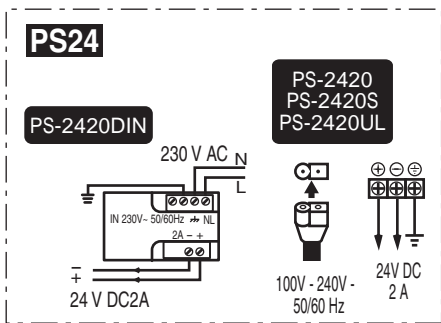

Sub trunk line system (1) B



Sub trunk line system (2) A



Sub trunk line system (2) B



- Expanded video bus control unit GT-VBX

⚠ Connector cable length: 40 cm

- Expanded bus control unit GT-BCX

⚠ There are 4 groups each of R1 and R2 terminals on each trunk line terminal including COMMON1, COMMON2, SUB1A, SUB1B, SUB2A, and SUB2B. Terminals with the same name are connected together in the same trunk line terminal, so these trunk line terminals can be used as distribution points.

For connecting the lift control adaptor GTW-LC, refer to the GTW-LC Installation & Operation Manual.

- Bus control unit GT-BC

⚠ Do not connect 2 or more GT-BC units on the same trunk line.

4-5 Option connector

⚠ 1. To prevent shorts, be sure to cut unused lead wires at the bottom and insulate the ends.

⚠ 2. Screen settings are necessary for the GT-2C-L/GT-2C. Make sure to refer to "SETTINGS (GT-2C-L/GT-2C)" to perform screen settings.

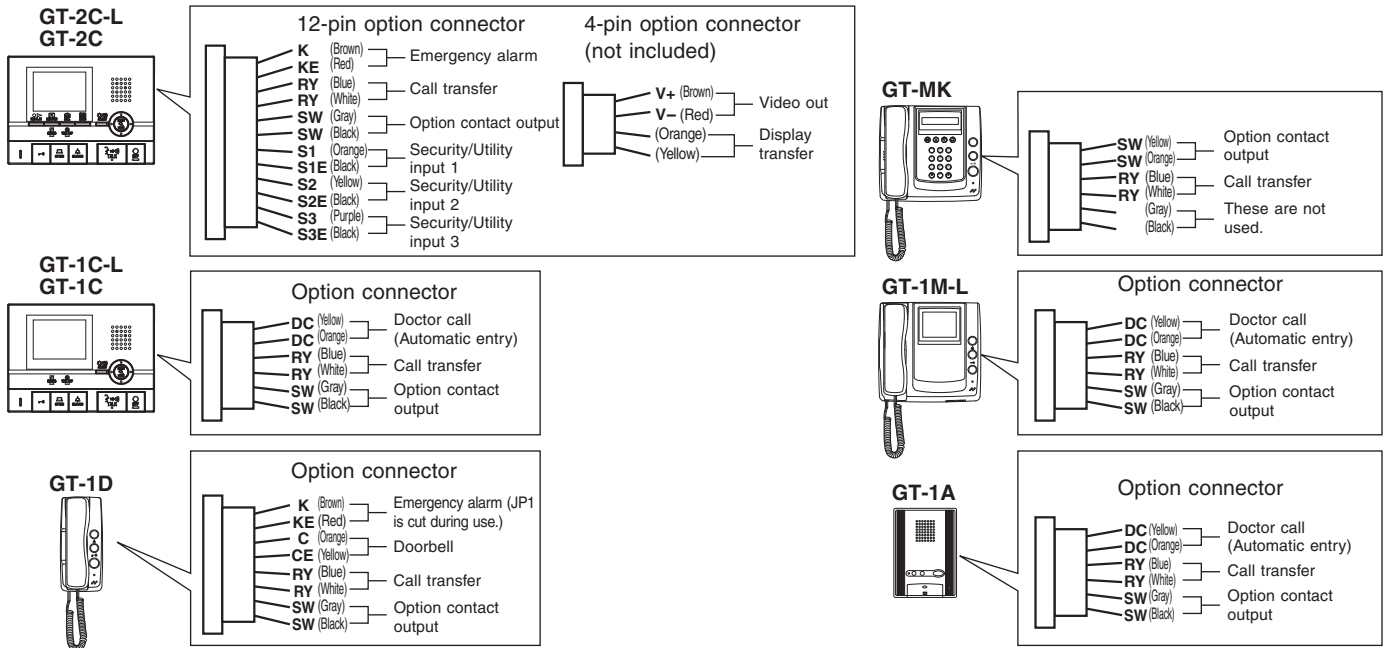

Emergency alarm

The emergency alarm switch can be connected.

N/C contact (locked type)

DC 12 V/0.1 A or higher

Call notification

Using the external signaling relay GT-RY allows for the external buzzer to be linked during calling.

Option contact output

External units such as lights can be operated with the option button.

Contact capacity: Maximum overload AC/DC 24 V, 1 A

Minimum overload DC 5 V, 100 mA

Security/Utility input 1 to 3

Input method	N/O or N/C dry closure contact
	External sensor input (start signal only detection method)
Detection confirmation time	100 msec or more
Contact resistance	N/O: 1 k Ω or less/N/C: 50 k Ω or more
Terminal short current	1 mA or less
Voltage between terminals	DC 3.3 V or less (when open between terminals)

Video out

Video can be output to DVRs etc.

(NTSC, 1 V_{p-p}/75 Ω) Wiring distance: 3 m

NOTES: When a video signal is output, residential stations may produce a sound depending on the installation environment.
(The screen playing recorded pictures is not output.)

Display transfer

External monitors can be activated via the external signaling relay GT-RY.

Doctor call (automatic entry)

This makes it possible to use the doctor call (automatic entry) function at residential stations.

- GT-1C-L/GT-1C, GT-1M-L, GT-1A

Short the DC terminal.

- GT-1D

Cut (open) the jumper JP4.

Doorbell

The doorbell can be connected.

N/O contact (non-locked type)

DC 12 V/0.1 A or higher

4-6 External signaling relay connection

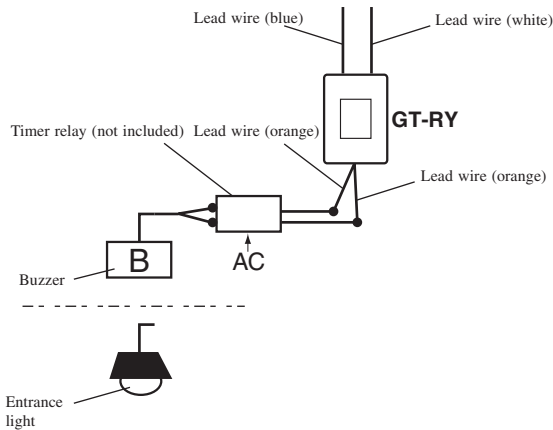

* When the GT-RY is connected, the separate option connector (4-5) is required.

GT-RY contact specification: AC/DC 24 V, 0.5 A

5 SETTINGS (COMMON AREA)

5-1 Setting list

Perform the following settings at an entrance station or security guard station.



Depending on the setting item, some items are set by switching DIP switches and some are set using the program mode menu.

⚠ After any DIP switches are switched or any changes are made in the program mode, turn the power supply off and on again. In some cases, the settings may not be changed.

- The program menu varies according to the unit.

Inst. Setting = Setting that must be set during installation.

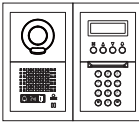
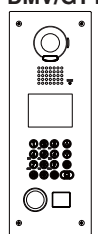
= These items can be set according to the installation equipment and application.

Setting item	GT-NS-V/GT-NS, GT-DA-L/GT-DA, GT-VA 	GT-DMV/GT-DM 	GT-MK 	Page no.
Entrance station and security guard station ID setting	Inst. Setting	Inst. Setting	Inst. Setting	34
Changing the ID code	Inst. Setting	Inst. Setting	Inst. Setting	34
Writing resident information	Inst. Setting	Inst. Setting	Inst. Setting	35
Manual setting of residence IDs				36
Setting up the system	Inst. Setting	Inst. Setting	Inst. Setting	37
Transferring link information				40
Link check	Inst. Setting	Inst. Setting	Inst. Setting	41
Setting the input timeout timer				42
Display language selection	Inst. Setting	Inst. Setting	Inst. Setting	43
Guidance language selection	Inst. Setting	Inst. Setting		43
Setting messages and the standby screen				44
Room number display setting				45
Scroll speed setting				45
Setting the sort order for searching				46
Access code setting	Inst. Setting	Inst. Setting		47
Entrance monitor setting				48
Call screen setting				48
Surveillance camera switching setting				49
Adjusting screen brightness				49
LCD operation mode setting				50
Security guard station transfer setting				50
Setting prohibition on calls from security guard stations				50
Entrance zoom picture pre-set				51
Visibility settings (daytime only)				52
Entrance night illumination setting				53
Direct select type light button setting				53

5-2 Setting method

Program Mode

Settings can be performed with the GT-NS-V/GT-NS, GT-DMV/GT-DM, and the GT-MK.

⚠ Programming cannot be performed from a security guard station if there is a record of an emergency alarm.

1 Check on the display that the unit is in the standby mode.

- When performing the initial settings, "WELCOME" will display at the entrance station and "AIPHONE" will display on the security guard station GT-MK.



2 Press [#], [*] on the 10 key and enter the 4-digit ID code.

- The initial ID code is "1111".



3 When "RE-ENTER ID CODE" is displayed, re-enter [*] and the 4-digit ID code.

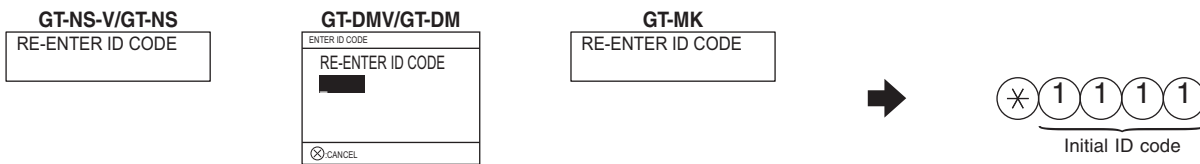

4 After entering the program mode, the first setting item displays.

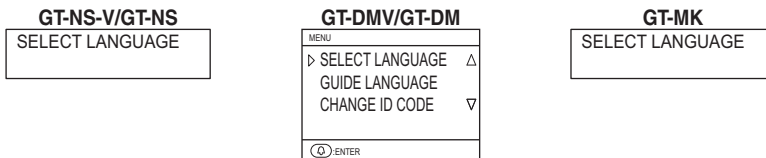

5-3 Entrance station and security guard station ID setting

IDs for entrance stations and security guard stations are set using the DIP switches of units.

The setting shown with "#1" is the setting at the time of shipment. When installing multiple entrance stations and security guard stations, make sure to set IDs.

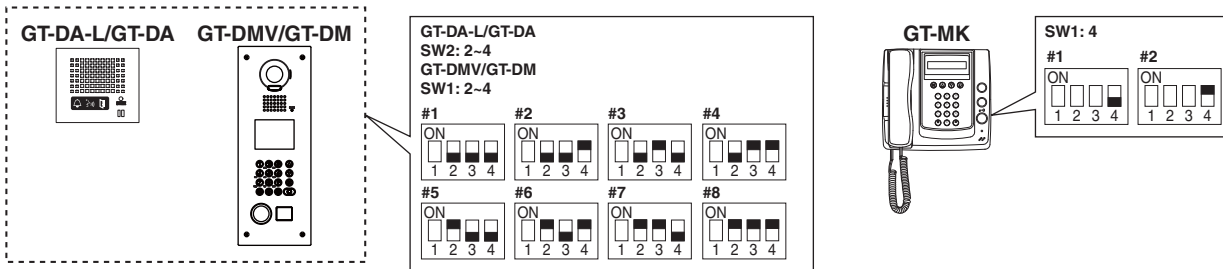

5-4 Changing the ID code

Before performing settings, it is recommended that users register an ID code so that other people cannot access the system.

Enter the program mode with the GT-NS-V/GT-NS, GT-DMV/GT-DM or GT-MK and select "CHANGE ID CODE".

GT-NS-V/GT-NS/GT-MK

CHANGE ID CODE

GT-DMV/GT-DM

MENU
SELECT LANGUAGE Δ
GUIDE LANGUAGE
▷ CHANGE ID CODE ▽
ENTER



CHANGE ID CODE

*1111

Current ID code

CHANGE ID CODE
ENTER ID CODE
*1111
* + 4 DIGITS
ENTER

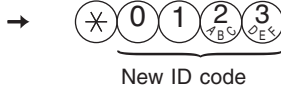

The current ID code is displayed.

Enter the new 4-digit ID code (ex.: 0123) after entering [*] on the 10 key.

CHANGE ID CODE

*0123

ID code after change

CHANGE ID CODE
ENTER ID CODE
*0123
* + 4 DIGITS
ENTER



* If you have forgotten your newly registered ID code, set the switch below to ON for approximately 2 seconds. The ID code will return to the initial setting of "1111".

GT-NS-V/GT-NS

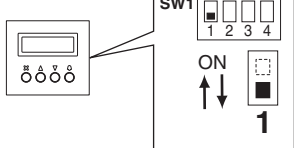

GT-DMV/GT-DM

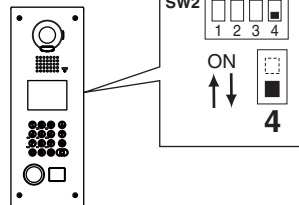

GT-MK

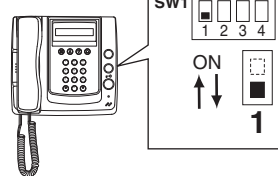

5-5 Writing resident information

If the entrance station is a 10 key type or a GT-MK, program the resident information (names and room numbers) before performing the system settings. Up to 500 resident information entries can be registered.

Programming with a PC

- You can use a PC to enter data and write in or change resident names.
- In your PC, install the setup tool program from the CD that comes with the GT-BC. A caution screen may display, but continue with installation.
- Use the USB cable that comes with the GT-NS-V/GT-NS, GT-DMV/GT-DM, and GT-MK to connect to the PC being used.

* For information on how to use the setup tool, see the text (.txt) file that is installed in the same folder as the setup tool (.exe). Saving programmed data and resident information data to your PC is recommended.

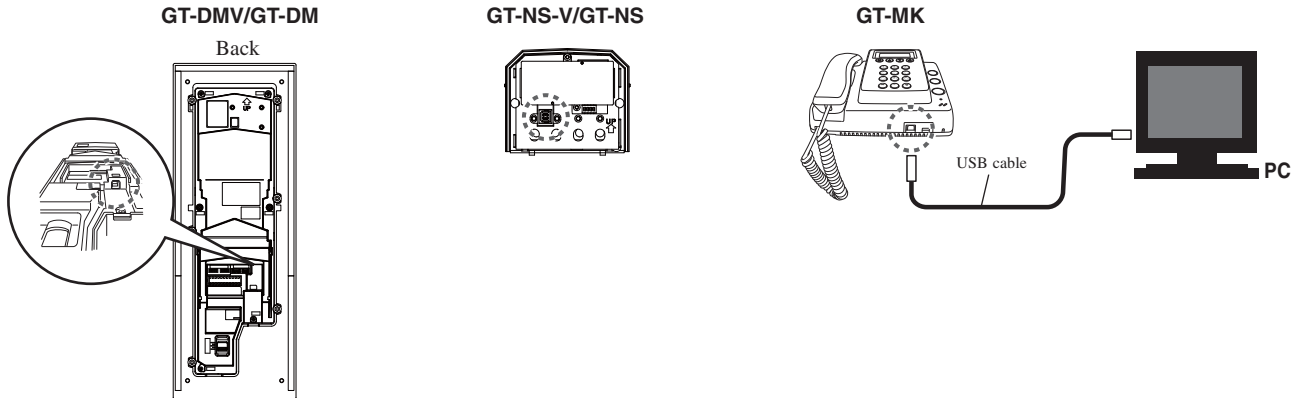

Programming with the GT-NS-V/GT-NS, GT-DMV/GT-DM, or GT-MK. Enter the program mode and select "RESIDENT INFO." from the menu.

GT-NS-V/GT-NS/GT-MK
RESIDENT INFO.

GT-DMV/GT-DM
MENU
ACCESS CODE
▷ RESIDENT INFO.
SET TIMER
◁ ENTER



ROOM #

RESIDENT INFO.
ROOM # [REDACTED]
MAX 6 DIGITS
◁ NEXT ⊗ QUIT

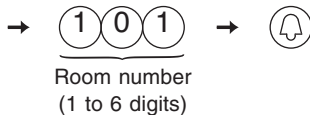

Enter a room number using 1 to 6 digits.

101

RESIDENT INFO.
ROOM # 101
[REDACTED]
MAX 32 LETTERS
◁ NEXT ⊗ QUIT # ANOTHER NAME

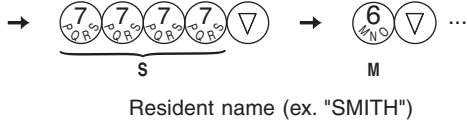

Register the resident name.

- Resident names can have up to 32 characters.
- Up to 4 names can be registered for one residence (same room number). To register multiple names, press [#] on the 10 key after entering a name and enter the next name.
- Press [*] to delete the room number and resident name.

101
SMITH

RESIDENT INFO.
ROOM NO. 101
SMITH
MAX 32 LETTERS
◁ NEXT ⊗ QUIT # ANOTHER NAME

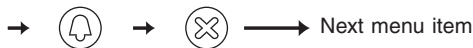

5-6 Manual setting of residence IDs

Residential station IDs are automatically assigned during link setting. However, with the GT-2C-L/GT-2C and GT-1C-L/GT-1C units only, they can be set manually using the switches on the unit. All are set to OFF in the initial settings.

When replacing a residential station due to malfunction, resetting the link is unnecessary as the link can be maintained by adjusting the switches.

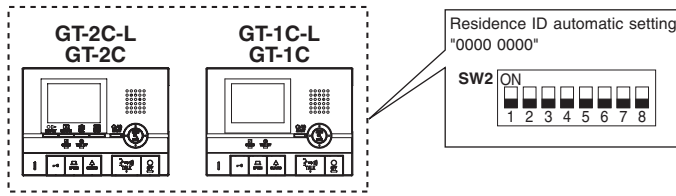

1 Change the decimal notation IDs to binary IDs to set the residence IDs.

- 1 indicates (ON) and 0 indicates (OFF).
- For the binary notation, refer to the appendix information about the setup tool and perform settings as shown below.

Decimal notation	Binary notation	DIP switch
1	0000 0001	<input type="checkbox"/> <input type="checkbox"/> <input type="checkbox"/> <input type="checkbox"/> <input type="checkbox"/> <input type="checkbox"/> <input type="checkbox"/> <input type="checkbox"/>
2	0000 0010	<input type="checkbox"/> <input type="checkbox"/> <input type="checkbox"/> <input type="checkbox"/> <input type="checkbox"/> <input type="checkbox"/> <input type="checkbox"/> <input type="checkbox"/>
3	0000 0011	<input type="checkbox"/> <input type="checkbox"/> <input type="checkbox"/> <input type="checkbox"/> <input type="checkbox"/> <input type="checkbox"/> <input type="checkbox"/> <input type="checkbox"/>
4	0000 0100	<input type="checkbox"/> <input type="checkbox"/> <input type="checkbox"/> <input type="checkbox"/> <input type="checkbox"/> <input type="checkbox"/> <input type="checkbox"/> <input type="checkbox"/>
}	}	}
48	0011 0000	<input type="checkbox"/> <input type="checkbox"/> <input type="checkbox"/> <input type="checkbox"/> <input type="checkbox"/> <input type="checkbox"/> <input type="checkbox"/> <input type="checkbox"/>
}	}	}
250	1111 1010	<input type="checkbox"/> <input type="checkbox"/> <input type="checkbox"/> <input type="checkbox"/> <input type="checkbox"/> <input type="checkbox"/> <input type="checkbox"/> <input type="checkbox"/>

2 Create a correlation table with the setup tool between the IDs set for residences and the resident names and export this to the entrance station or security guard station.

- * For information on how to use the setup tool, see the text (.txt) file that is installed in the same folder as the setup tool (.exe). Saving programmed data and resident information data to your PC is recommended.

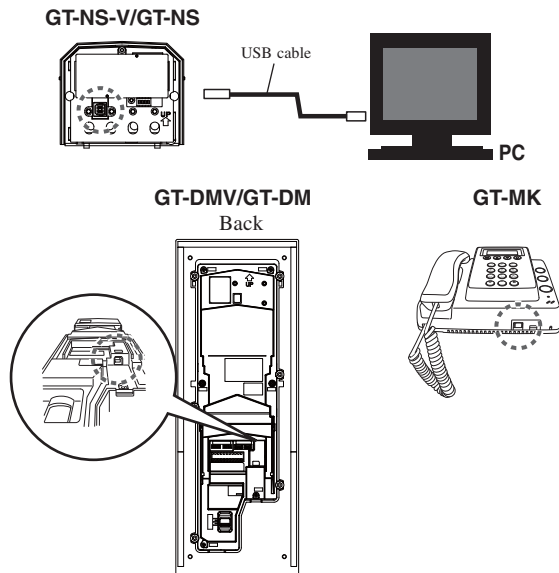

5-7 Setting up the system

System settings can be performed from an entrance station or security guard station.

- ⚠ If residential stations are mixed, be sure to perform [5-7 Setting up the system] after [5-6 Manual setting of residence IDs]. If a sequence mistake is made, IDs may be duplicated and operation may not occur.

Performing settings from an entrance station

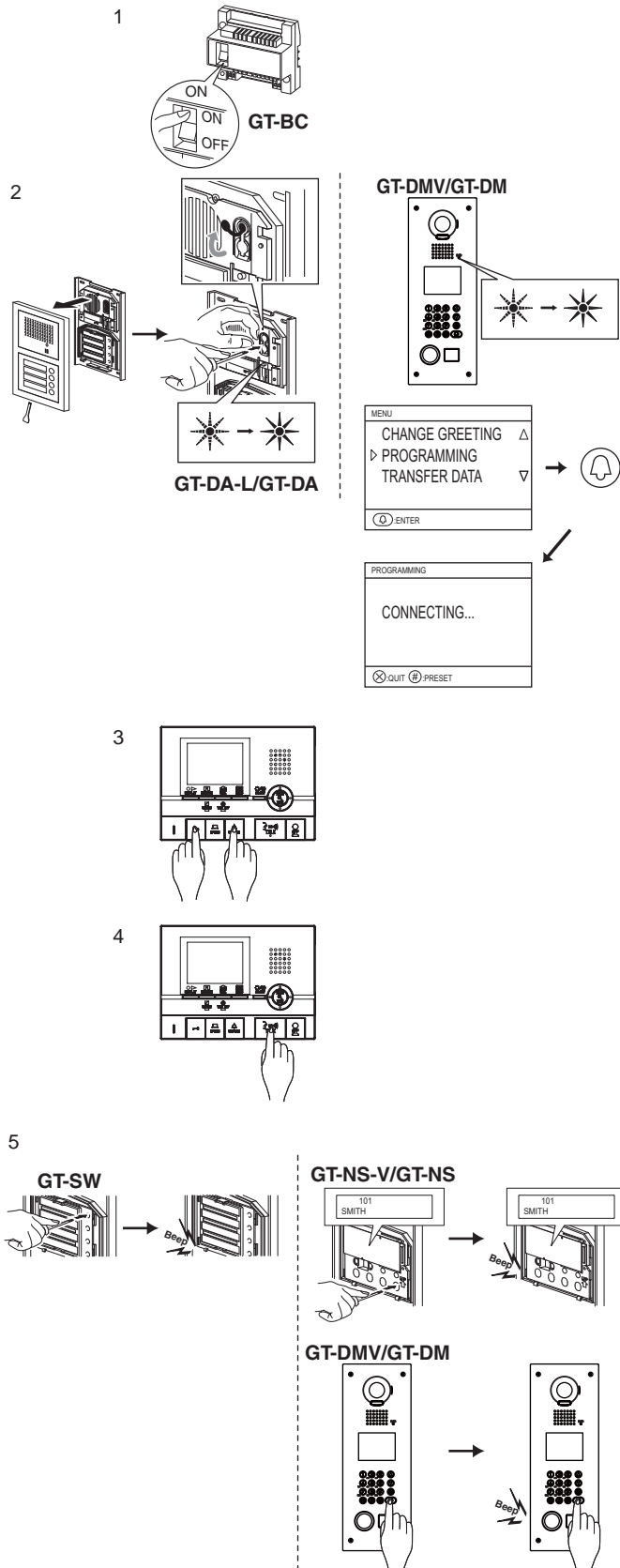

1 Check that all units are mounted and wired correctly, and then turn on the power switch of the GT-BC.

2 With the GT-DA/GT-DA-L, loosen the base screw of the frame and open and remove the front panel. Remove the rubber cap and use a fine screwdriver to push the program switch. With the GT-DMV/GT-DM, enter the program mode and select "PROGRAMMING" from the menu. Wait until "CONNECTING..." is displayed. The in use LED will blink for approximately 6 to 15 seconds.

3 Once the in use LED is lit solid, press and hold down the door release button while holding down the security guard station call/light button of the residential station. A beep will sound approximately 5 seconds later and all of the residence IDs will be initialized.

CAUTION: Performing the above operation will delete all link data in the residential station and return it to the initial settings. Only perform this operation when performing settings the first time after mounting a residential station. When changing settings, skip this procedure.

4 Check that the in use LED is lit, and press the TALK button of the first residential station. With the handset type module, lift the handset. The corresponding communication channel will be established.

5 GT-SW: Press the relevant call button. (Do not press the button longer than 1 second.) GT-NS-V/GT-NS, GT-DMV/GT-DM: Display the assigned room no. and press the button. (Do not press the button longer than 1 second.) An electronic beep will be emitted once. Link setting can be performed for up to 4 stations. (With registration, the electronic beep will sound a number of times equal to the number of connected stations.)

6

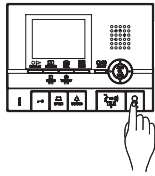

6 Press the OFF button to finish programming. With the handset type module, return the handset. Repeat steps 3 to 6 to program all residential stations.

7

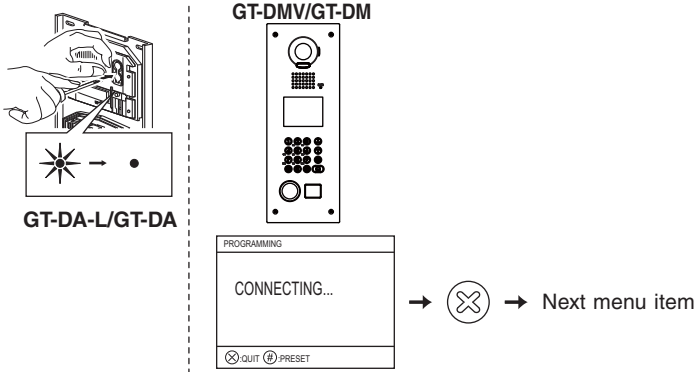

7 Press the program switch of the GT-DA-L/GT-DA to finish programming.
The in use LED will go out.
For the GT-DMV/GT-DM, press the (X) button.

* Erasing links

5

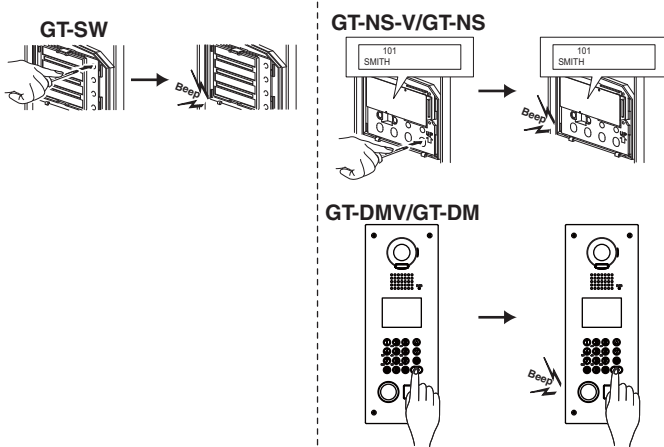

After step 5, press and hold the (C) button until the confirmation tone sounds.
A beep will sound and the link to the corresponding residential station will be erased.

Performing settings from a security guard station

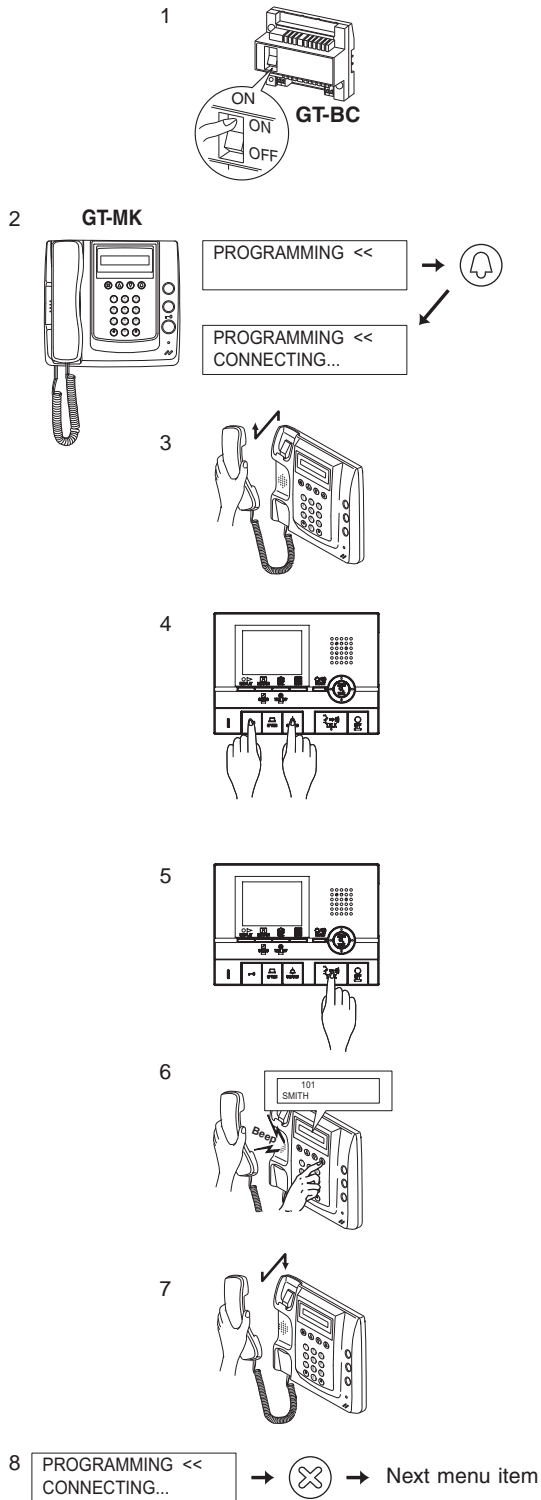

1 Check that all units are mounted and wired correctly, and then turn on the power switch of the GT-BC.

2 Enter the program mode at the GT-MK and select "PROGRAMMING" from the menu. Wait until "CONNECTING..." is displayed.

3 Lift the handset of the GT-MK.

4 Press and hold down the door release button while holding down the security guard station call/light button of the residential station. A beep will sound approximately 5 seconds later and all of the residence IDs will be initialized.

CAUTION: Performing the above operation will delete all link data in the residential station and return it to the initial settings. Only perform this operation when performing settings the first time after mounting a residential station. When changing settings, skip this procedure.

5 Press the talk button on the first residential station. With the handset type module, lift the handset. The corresponding communication channel will be established.

6 Display the assigned room no. and press the button. (Do not press the button longer than 1 second.) An electronic beep will be emitted once. Link setting can be performed for up to 4 stations. (With registration, the electronic beep will sound a number of times equal to the number of connected stations.)

7 Return the handset of the GT-MK. Repeat steps 4 to 6 to program all residential stations.

8 Press the button to finish programming.

* Erasing links

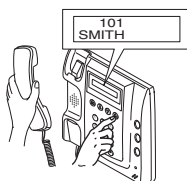

After step 6, press and hold the button until the confirmation tone sounds. A beep will sound and the link to the corresponding residential station will be erased.

5-8 Transferring link information

Transfer link setting information set at an entrance station or security guard station to other entrance stations and security guard stations.
Enter the program mode and select "TRANSFER DATA".

GT-NS-V/GT-NS, GT-MK

GT-DMV/GT-DM

TRANSFER DATA

MENU
CHANGE GREETING Δ
PROGRAMMING ▽
▷ TRANSFER DATA ▽
⓪ ENTER



ENTER UNIT ID#
MAIN ENTRANCE: 2

TRANSFER DATA
ENTER UNIT ID#
MAIN ENTRANCE: 2
0 FOR GUARD
⓪ ENTER ⊗ QUIT



Enter an entrance station number (1 to 16) for the transferred station. If "0" is entered, a security guard station will be the transferred station.

With an expanded system, the entrance stations IDs are as shown below.

- Connected to same common line: ID remains the same (Ex.: Enter "2" to transfer to #2)
- Connected to separate common line: ID + 8 (Ex.: Enter "9" to transfer to #1)

ENTER UNIT ID#
SECURITY GUARD: 2

TRANSFER DATA
ENTER UNIT ID#
SECURITY GUARD: 2
⓪ ENTER ⊗ QUIT

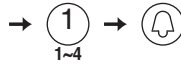

Enter a security guard station number (1 to 4) for the transferred station.
With an expanded system, the security guard station IDs are as shown below.

- Connected to same common line: ID remains the same (Ex.: Enter "2" to transfer to #2)
- Connected to separate common line: ID + 2 (Ex.: Enter "3" to transfer to #1)

TRANSFERRING.

TRANSFER DATA
TRANSFERRING...

During transfer, "TRANSFERRING..." is displayed.



DATA TRANSFERRED

TRANSFER DATA
DATA TRANSFERRED
⊗ QUIT

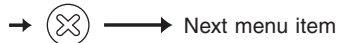

5-9 Link check

Performing settings from an entrance station (Unit type)

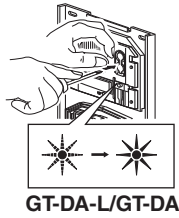

Press the program switch of the GT-DA-L/GT-DA for at least 5 seconds. The in use LED will light up after blinking.

GT-SW: Press the relevant call button.

GT-NS-V/GT-NS: Select the room and press the Ⓞ button.

An electronic sound will be emitted once if the link is normal. If the link is abnormal, an error sound will be emitted.

Performing settings from an entrance station (Integrated type), security guard station

GT-DMV/GT-DM

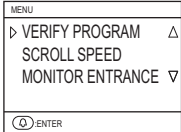

GT-MK

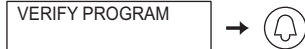

Enter the program mode and select "VERIFY PROGRAM".

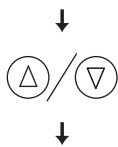
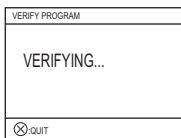

Select the room and press the Ⓞ button.

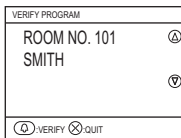

With a security guard station, an electronic sound will be emitted once if the link is normal. If the link is abnormal, an error sound will be emitted. With an entrance station (Integrated type), "CORRECT" will display if the link is normal and "ERROR" will display if it is not normal.

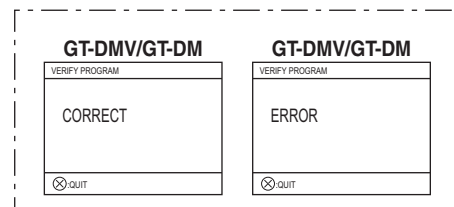

5-10 Setting the input timeout timer

Enter the program mode with the GT-NS-V/GT-NS, GT-DMV/GT-DM or GT-MK and select "SET TIMER".

- Operation timer: If the operation panel is not operated for a certain period of time, the system returns to standby mode. The initial setting is 15 seconds.
- Program timer: If an operation is not performed for a certain period of time in the program mode, the program mode will automatically be cancelled. The initial setting is 60 seconds.
- Call timer: Calls from entrance stations and security guard stations will expire after a certain period of time. The initial setting is 45 seconds.
- Door release timer: Set the time for when the door is locked again after a door release operation. The initial setting is 0 seconds.

GT-NS-V/GT-NS, GT-MK

SET TIMER

GT-DMV/GT-DM

MENU
ACCESS CODE Δ
RESIDENT INFO. ▽
▷ SET TIMER
Ⓜ ENTER



OPERATION TIMER
15

SET TIMER
OPERATION TIMER
15 s
INPUT 15-99
Ⓜ NEXT ⊗ QUIT

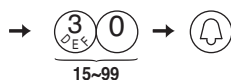

Set the operation timer in the range from 15 to 99 seconds.

PROGRAM TIMER
60

SET TIMER
PROGRAM TIMER
60 s
INPUT 30-99
Ⓜ NEXT ⊗ QUIT

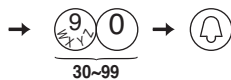

Set the program timer in the range from 30 to 99 seconds.

CALL DURATION
45

SET TIMER
CALL DURATION
45 s
INPUT 30-99
Ⓜ NEXT ⊗ QUIT



Set the call timer in the range from 30 to 99 seconds.

* Entrance stations (Integrated type) only

SET TIMER
RELEASE TIMER
15 s
INPUT 00-20
00=WHILE PRESSED
Ⓜ NEXT ⊗ QUIT

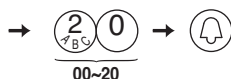

Set the door release timer in the range from 00 to 20 seconds.
If the timer is set at 00 seconds, the door will be released only while the button is pressed.



Entrance station (Unit type) door release timer: Set the GT-DA-L/GT-DA with volume VR1.

GT-DA-L/GT-DA



20
0.5 M
0.5 to 20: 0.5 to 20 seconds
M: While door release button is pressed

5-11 Display language selection

Start the program mode with the GT-NS-V/GT-NS, GT-DMV/GT-DM or GT-MK and select "SELECT LANGUAGE".

The initial setting is English.

Select English, French, German, Spanish, Dutch, or Italian.

GT-NS-V/GT-NS, GT-MK

SELECT LANGUAGE

GT-DMV/GT-DM

MENU
 ▷ SELECT LANGUAGE Δ
 GUIDE LANGUAGE ▽
 CHANGE ID CODE ▽
 ⊞ ENTER



SELECT LANGUAGE
 ENGLISH

SELECT LANGUAGE
 ▷ ENGLISH Δ
 FRANÇAIS ▽
 DEUTSCH ▽
 ⊞ ENTER



ENGLISH
 FRANÇAIS
 DEUTSCH
 ESPAÑOL
 NEDERLANDS
 ITALIANO

↑ ↓

5-12 Guidance language selection

Select the guidance language that will be heard when a call is received, etc. The initial setting is for no guidance.

GT-DA-L: Perform settings using combinations of 2 to 4 with SW3.

Select English, French, German, Spanish, Dutch, Italian or no guidance.

GT-DA-L

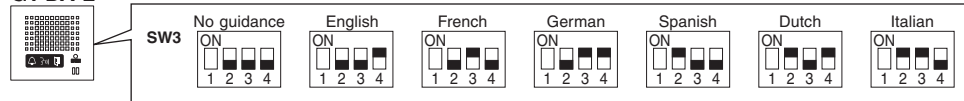

GT-DMV/GT-DM: Start the program mode and select "GUIDE LANGUAGE".

Select English, French, German, Spanish, Dutch, Italian or no guidance.

GT-DMV/GT-DM

MENU
 SELECT LANGUAGE Δ
 ▷ GUIDE LANGUAGE ▽
 CHANGE ID CODE ▽
 ⊞ ENTER



GUIDE LANGUAGE
 ▷ NO GUIDANCE Δ
 ENGLISH ▽
 FRANÇAIS ▽
 ⊞ ENTER



NO GUIDANCE
 ENGLISH
 FRANÇAIS
 DEUTSCH
 ESPAÑOL
 NEDERLANDS
 ITALIANO

↑ ↓

5-13 Setting messages and the standby screen

GT-NS-V/GT-NS: Use 3 of SW1 to change the greeting message to an operation message. The initial setting is for a greeting message.

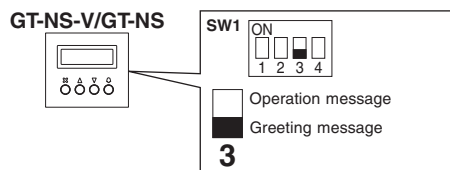

GT-DMV/GT-DM: Start the program mode and select "STANDBY SCREEN".

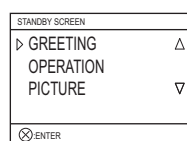
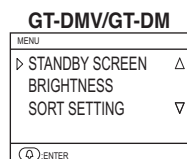

Select from the following in the standby screen display.

- Greeting message
- Operation message
- Picture

* Changing the greeting message

GT-NS-V/GT-NS, GT-DMV/GT-DM: Start the program mode and select "CHANGE GREETING".

Greetings can have up to 160 characters.

Press [*] to delete the greeting message.

GT-NS-V/GT-NS

CHANGE GREETING

GT-DMV/GT-DM

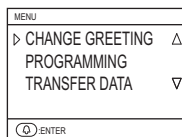

CHANGE GREETING
WELCOME

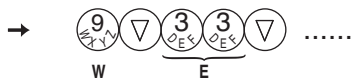
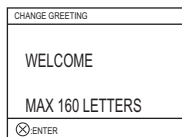

Ex.: "WELCOME TO..."

CHANGE GREETING
WELCOME TO ...



* Uploading a picture

For details, see the text (.txt) file that is installed in the same folder as the setup tool (.exe).

5-14 Room number display setting

Set the entrance station display to show room numbers or to display only resident names. The initial setting is for the room number to also display.
 GT-NS-V/GT-NS: Switch this setting with 2 of SW1.

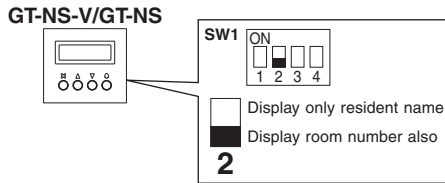

GT-DMV/GT-DM: Enter the program mode and select "DISPLAY ROOM NO.". Select ON (room number also displays) or OFF (only resident name displays).

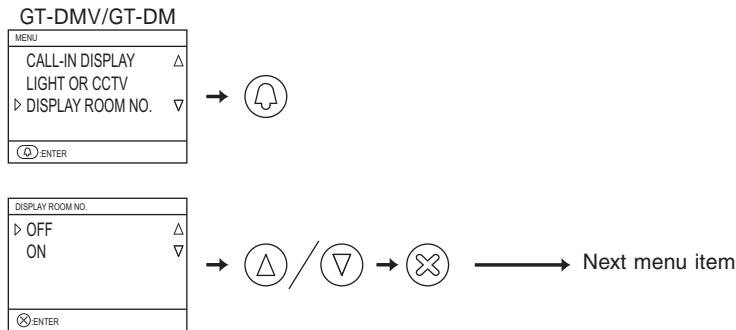

5-15 Scroll speed setting

The scroll speed for messages and resident names (17 characters or more) that display on entrance station and security guard station displays can be changed. The initial setting is "5".

GT-NS-V/GT-NS, GT-DMV/GT-DM, GT-MK: Enter the program mode and select "SCROLL SPEED".

Set a digit from 0 to 9. 0 = Slow 9 = Fast.

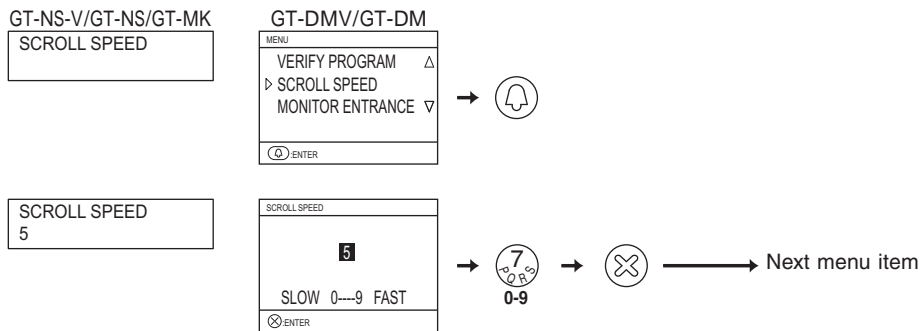

5-16 Setting the sort order for searching

Select either name order or room number order for searching at entrance stations and security guard stations. The initial setting is name order.
GT-NS-V/GT-NS, GT-DMV/GT-DM, GT-MK: Enter the program mode and select "SORT SETTING".

GT-NS-V/GT-NS/GT-MK

SORT SETTING

GT-DMV/GT-DM

MENU
STANDBY SCREEN Δ
BRIGHTNESS
▷ SORT SETTING ▽
⊗ENTER



SORT SETTING
SORT BY NAME
Current search order

SORT SETTING
▷ SORT BY NAME Δ
SORT BY ROOM NO. ▽
⊗ENTER

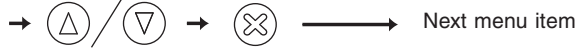

5-17 Access code setting

Up to 500 access codes can be set for door release at an entrance station.

The number of digits for access codes can be set anywhere in the range from 4 to 6. The initial setting is 4 digits.

* Setting the access code number of digits

GT-NS-V/GT-NS, GT-DMV/GT-DM: Enter the program mode and select "ACCESS CODE".

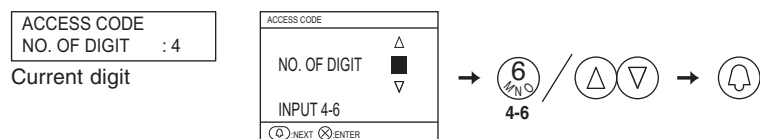
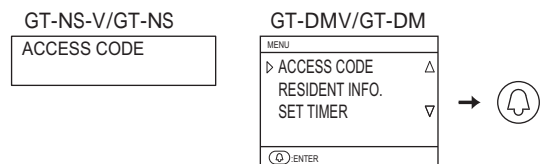

Set the number of digits in the range from 4 to 6.

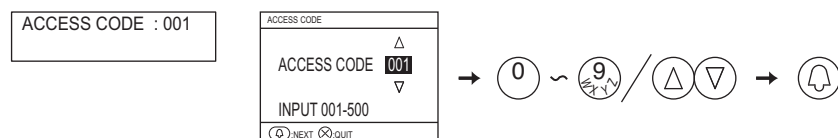

Select the access code to set from "001" to "500".
Enter the number directly using the number keys or select it by using the and buttons.

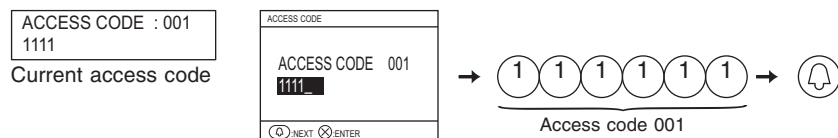

Enter the access code.
* Codes with more digits than the set number of digits for access codes cannot be entered.

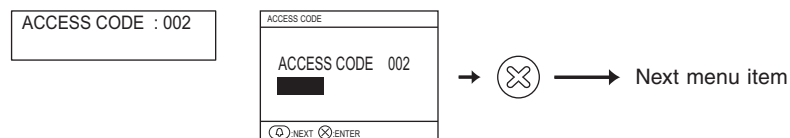

5-18 Entrance monitor setting

Monitoring with the entrance station camera from a residential station can be set to be possible or not possible. The initial setting makes this not possible.

GT-DA-L/GT-DA: Switch this setting with 1 of SW2.

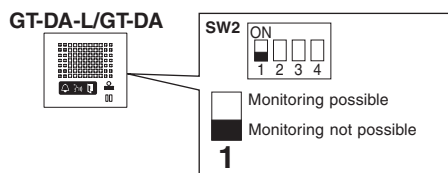

GT-DMV/GT-DM: Enter the program mode and select "MONITOR ENTRANCE".

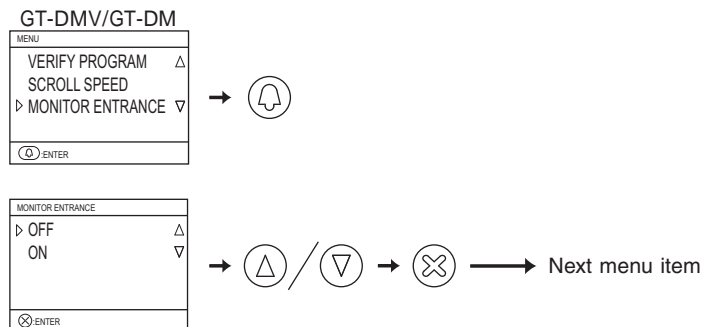

5-19 Call screen setting

Screen switching during a call can be set to "ZOOM", "WIDE", "ZOOM 3s >> WIDE", or "WIDE 3s >> ZOOM". The initial setting is "ZOOM".

GT-VA: Switch this setting with 3 and 4 of SW1.

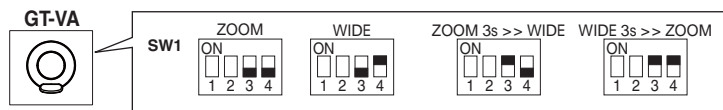

GT-DMV/GT-DM: Enter the program mode and select "CALL-IN DISPLAY".

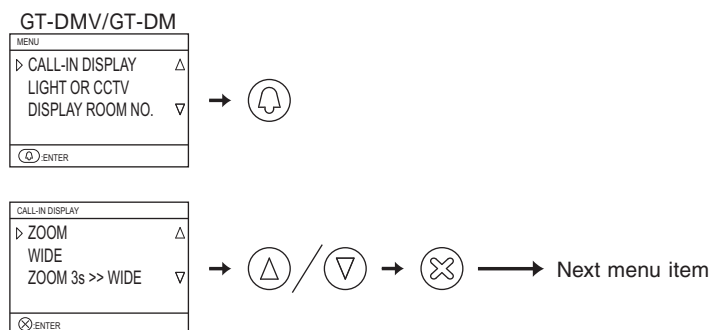

5-20 Surveillance camera switching setting

Select "LIGHT CONTROL" or "CCTV SWITCH" for the operation performed when the light button on a residential station is pressed. The initial setting is OFF ("LIGHT CONTROL").

GT-VA: Switch this setting with 2 of SW1.

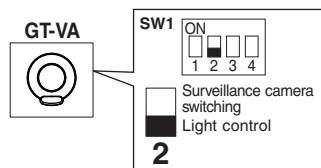

GT-DMV/GT-DM: Enter the program mode and select "LIGHT OR CCTV". Select using the Δ and ∇ buttons.

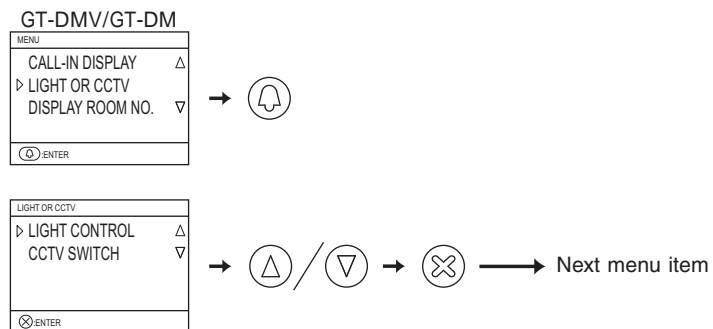

5-21 Adjusting screen brightness

Screen brightness can only be adjusted with the GT-DMV/GT-DM.

Start the program mode and select "BRIGHTNESS". Set a digit from 0 to 9. 0 = Dark 9 = Bright. The initial setting is "6".

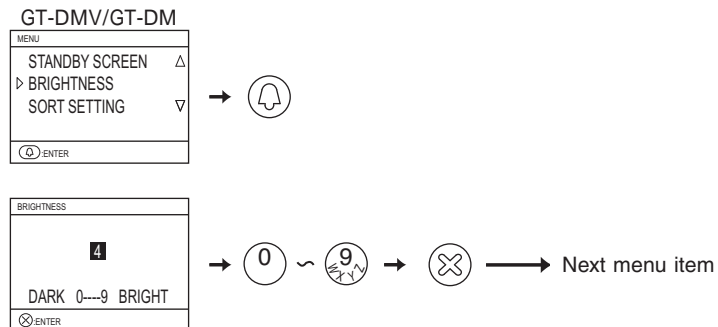

5-22 LCD operation mode setting

The LCD screen automatic ON function can only be set with the GT-DMV/GT-DM. The initial setting is sensor mode.

- Sensor mode: The LCD will automatically turn ON due to the sensor when a person approaches. The detection distance changes depending on the direction that the person approaching is facing.
- Energy saving mode: Detection is not performed by the sensor. When a button is operated, the LCD turns ON.

⚠ Do not place objects such as plants or trees in places monitored by the sensor. Also, placing the unit in very bright sunlit areas may prevent the sensor from working properly.

Switch this setting with 2 and 3 of SW1.

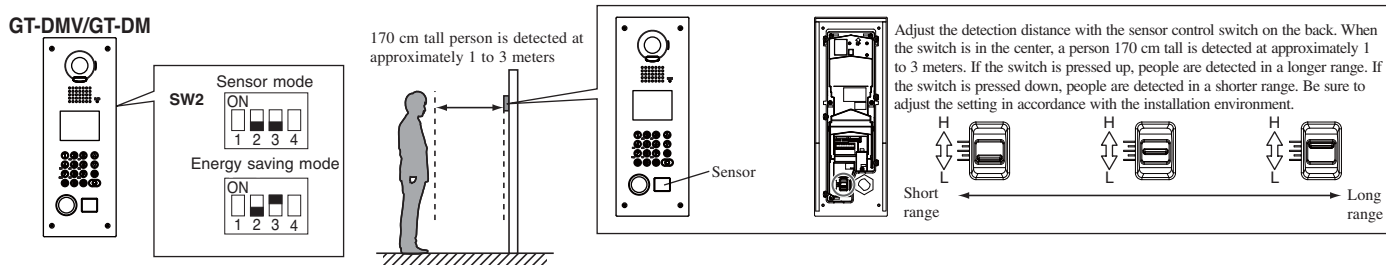

5-23 Security guard station transfer setting

Perform settings for whether calls to security guard stations and emergency alarms are transferred from the RY-RY terminal. The initial settings are for calls and alarms to be transferred.

GT-MK: Enter the program mode and select "OPTIONAL OUTPUT".

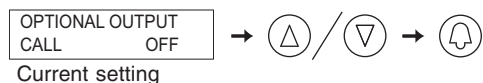

Select whether calls are transferred or not transferred.

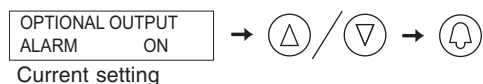

Select whether emergency alarms are transferred or not transferred.



5-24 Setting prohibition on calls from security guard stations

Security guard stations can be set only to receive calls. The initial setting allows outgoing calls.

GT-MK: Switch this setting with 3 of SW1.

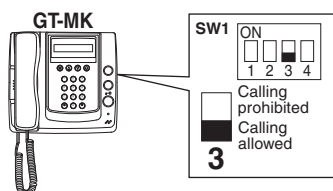

5-25 Entrance zoom picture pre-set

The picture can be set to display at the position set for zoom picture display when a residential station is called from an entrance station. The initial setting is for display at the center.

Perform this setting in the pre-set mode.

⚠ In the case of direct select type entrance stations and residential stations without a ZOOM/WIDE function, this pre-set is not possible.

Setting using an entrance station 10 key

Entrance Station (Unit type)

Start the pre-set mode

- 1 Loosen the base screw of the frame and open and remove the front panel.
- 2 Remove the rubber cap and use a fine screwdriver to push the program switch.

The in use LED will stay lit after blinking for approximately 6 to 15 seconds.

- 3 Press the [#] button on the GT-10K.

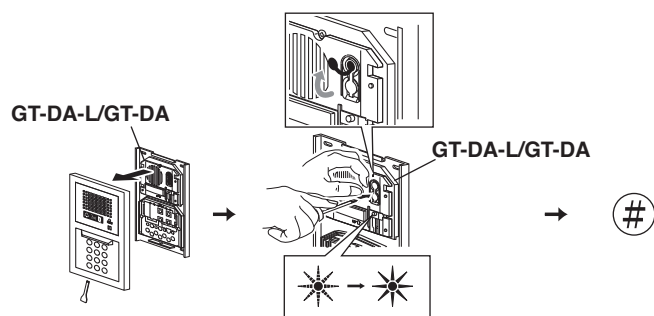

Perform the pre-set settings

Enter the pre-set position using [1] to [9] on the 10 key.

- At this time, the picture can be checked by pressing the talk button or lifting the handset on the residential station.

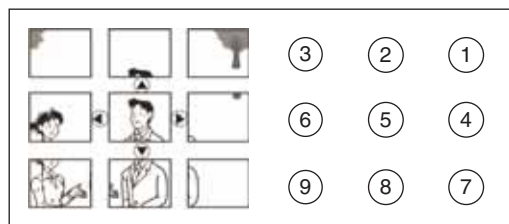

Entrance Station (Integrated type)

Start the pre-set mode

- 1 Enter the program mode and select "PROGRAMMING".
- 2 After the in use LED lights up, press [#] on the 10 key.

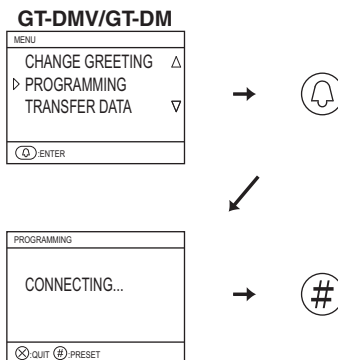

Perform the pre-set settings

Enter the pre-set position using [1] to [9] on the 10 key.

- At this time, the picture can be checked by pressing the talk button or lifting the handset on the residential station.

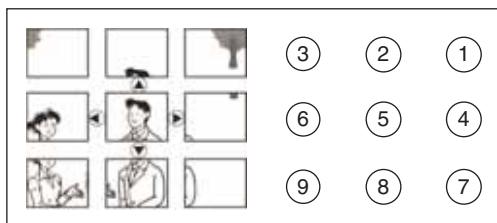

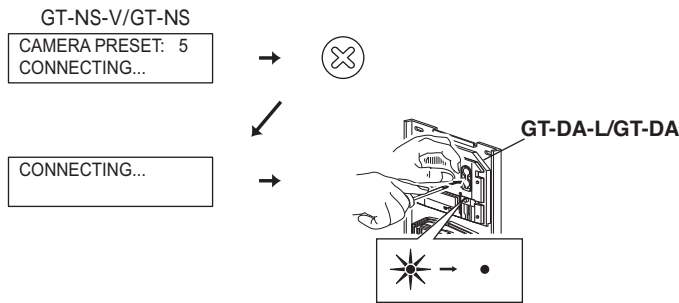

Quit the pre-set mode

- 1 Press the  button to register the pre-set position.
- 2 Press the program switch of the GT-DA-L/GT-DA to finish programming.





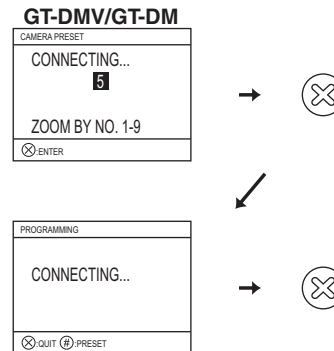

Quit the pre-set mode

- 1 Press the  button to register the pre-set position.
- 2 Press the  button to return to the menu.



Setting using a residential station (limited to stations with a zoom/wide function)

The picture can be set to display using a set zoom picture position for when a call is received from an entrance station. When switching from the wide screen to the zoom screen, the zoom screen displays starting from the pre-set position.

- 1 Enter the pre-set mode from an entrance station.
- 2 Start communication from a residential station to display the picture at the currently set pre-set zoom position.
- 3 Adjust the camera zoom position using the [, [, [, and [] buttons on the residential station.
- 4 Press the [ ZOOM/WIDE] button (for at least 2 seconds). A beep will sound and the position setting will be completed.
- 5 End residential station communication.
- 6 Exit the pre-set mode from the entrance station.

* Setting can be performed in the same manner even if the entrance station is in programming mode.

* Pressing the entrance station call button will set a link with a residence, but pre-set settings cannot be performed.



* The position set at one entrance station will be displayed at all linked residential stations.

NOTES:

1. To change the zoom screen position that has been set, perform the zoom screen settings again. The previous settings will be overwritten.
2. The set zoom screen position will also be displayed at the sub master monitor station.
* Pre-sets cannot be set from a sub master monitor station.

5-26 Visibility settings (daytime only)

When entrance station is installed at a location where backlighting makes viewing difficult, settings can be performed for easier viewing.

- 1 Enter the pre-set mode from an entrance station.
- 2 Start communication from a residential station to display the picture at the currently set pre-set zoom position.
- 3 Press the [ ADJUST] button to adjust the daytime brightness.
- 4 Press the [ ADJUST] button (for at least 2 seconds). A beep will sound and the setting will be completed.
- 5 End residential station communication.
- 6 Exit the program mode from the entrance station.

5-27 Entrance night illumination setting

At night, the illuminator LED automatically lights up during an entrance station call. It can be set to always be off if night illumination is unnecessary or it is too bright.

The initial setting is for the LED to automatically light up.

GT-VA, GT-DMV/GT-DM: Switch this setting with 1 of SW1.

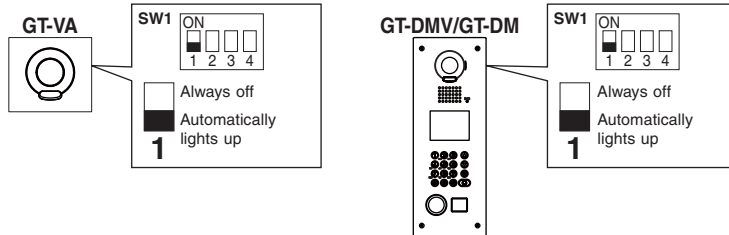

5-28 Direct select type light button setting

One of the call buttons on the GT-SW can be set as the light button.

- 1** Loosen the base screw of the speech module and open and remove the front panel.
- 2** Remove the rubber cap and use a fine screwdriver to push the setting switch. The in use LED will blink.
- 3** While the in use LED is blinking (approximately 15 seconds), press the call button to assign it as the light button. An electronic beep will be emitted once.

* A button cannot be simultaneously used as a residence call button and a light button.

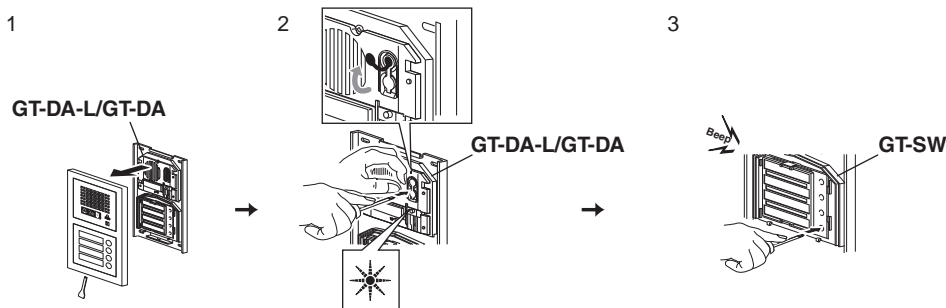

Press the call button assigned as the light button to light up the light connected to the entrance.



6 Setting (GT-2C-L/GT-2C)

- ⚠ 1. See the operation manual included with the GT-2C-L/GT-2C for the name and operating method for each part.
- ⚠ 2. Actual screens may vary depending on the system.
- ⚠ 3. **When settings are changed, turn the unit power supply off and on again. In some cases, the settings may not be changed.**

6-1 How to use the MENU

1 In the standby mode, press the [ADJUST] button and [ZOOM/WIDE] button until the warning screen displays. Press the [MENU] button in accordance with the warning screen.

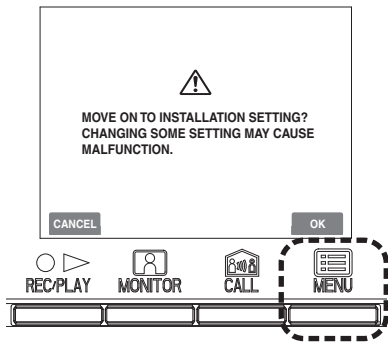

2 Press the [▲], [▼], [◀], and [▶] buttons in the "INSTALLATION" screen to select the item to be set and confirmed, and press the [MENU] button.

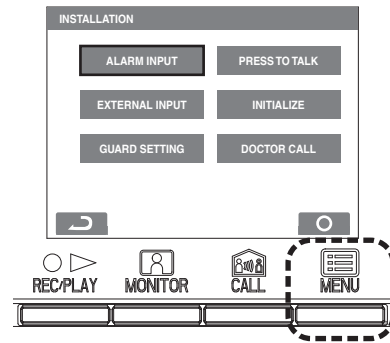

3 To finish changing settings, press the [OFF] button to return to the standby mode. In other cases, set by pressing the [MENU] button. Press the [REC/PLAY] button to cancel the settings and return to the previous screen.

6-2 Security guard station settings

Change the names of the security guard stations that display with the GT-2C-L/GT-2C.

1 After performing steps 1 in section 6-1, select "GUARD SETTING" in the "INSTALLATION" screen and press the [MENU] button.

2 In the "GUARD SETTING" screen, make a selection from "GUARD1" to "GUARD4" and press the [MENU] button. Select from "GUARD/CONCIERGE/RECEPTION/NOT DISPLAYED" for each. Press the [MENU] button to complete the settings.

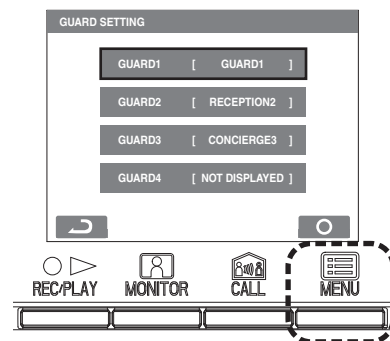

6-3 Emergency input settings

Set emergency input to be enabled or disabled.

- 1 After performing steps 1 in section 6-1, select "ALARM INPUT" in the "INSTALLATION" screen and press the [MENU] button.
- 2 Select "DISABLE", "N/O", or "N/C" in the "ALARM INPUT" screen. Press the [MENU] button to complete the settings and return to the previous screen.

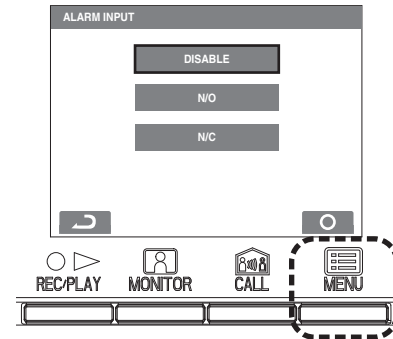

6-4 External input setting

Set external input (3 circuits) to security sensor or utility sensor.

- 1 After performing steps 1 in section 6-1, select "EXTERNAL INPUT" in the "INSTALLATION" screen and press the [MENU] button.
- 2 In the "EXTERNAL INPUT SETTING" screen, make a selection from "SENSOR1" to "SENSOR3" and press the [MENU] button.
- 3 Select from "DISABLE/UTILITY/SECURITY" in each screen from "SENSOR1 SETTING" to "SENSOR3 SETTING" and then press the [MENU] button.

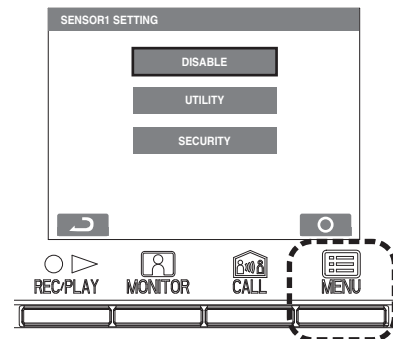
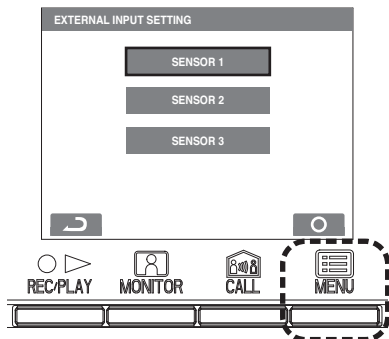

Utility sensor setting (detection method)

- 4 When "UTILITY" is selected, select "N/O" or "N/C" in the "UTILITY-SENSOR DETECTION METHOD" screen and press the [MENU] button.

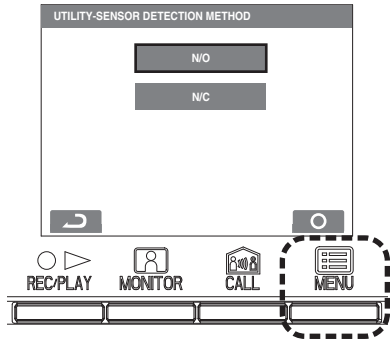

Security sensor setting (detection method)

- 4 When "SECURITY" is selected, select "N/O" or "N/C" in the "SECURITY-SENSOR DETECTION METHOD" screen and press the [MENU] button.

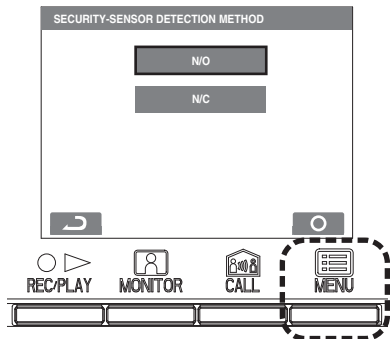

Security sensor (alarm transfer)

- 5 When [SECURITY] is selected, in the [EXTERNAL INPUT SETTING] screen, select [ALARM TRANSFER] and press the [MENU] button.

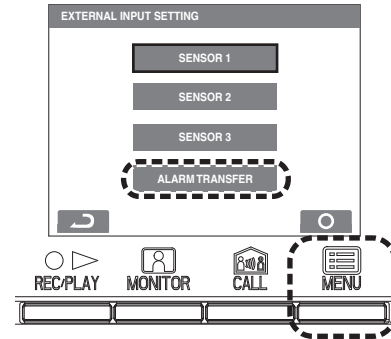

- 6 Select from "ENABLE/DISABLE" in the "SECURITY ALARM TRANSFER" screen. Press the [MENU] button to complete the settings.

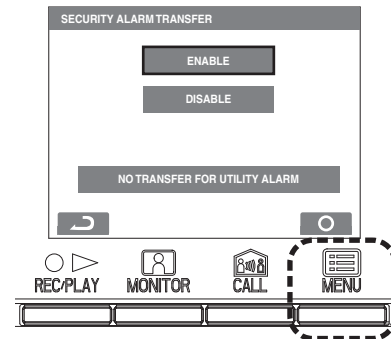

6-5 Doctor call setting

Set Doctor call to be enabled or disabled.

- 1 After performing steps 1 in section 6-1, select "DOCTOR CALL" in the "INSTALLATION" screen and press the [MENU] button.
- 2 Select from "ENABLE/DISABLE" in the "DOCTOR CALL" screen. Press the [MENU] button to complete the settings.

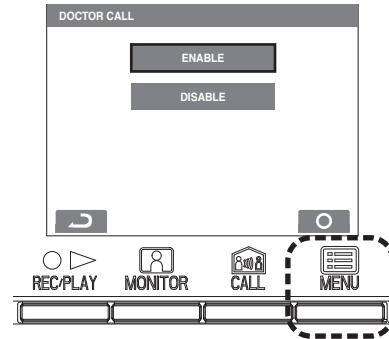

6-6 Press-to-talk setting

Set press-to-talk during communication to be enabled or disabled.

- 1 After performing steps 1 in section 6-1, select "PRESS TO TALK" in the "INSTALLATION" screen and press the [MENU] button.
- 2 Select from "ENABLE/DISABLE" in the "PRESS TO TALK" screen. Press the [MENU] button to complete the settings.

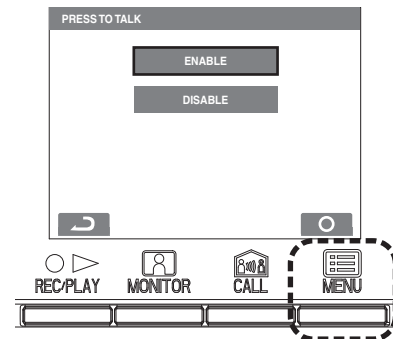

6-7 Initializing

All settings can be restored to their condition at the time of purchase.

- ⚠ 1. Recorded pictures are erased and settings are reset.
- ⚠ 2. Pre-set functions are not reset.

Settings reset with "Restor default setting"

Setting name	Description
DATE/TIME	JAN/01/2011 00 : 00
LANGUAGE	ENG FRA DEU ITA NED ESP
ENTRANCE CALL TONE	1 • 2 • 3 • 4 • 5
DOOR CALL TONE	1 • 2 • 3 • 4 • 5
GUARD CALL TONE	1 • 2 • 3 • 4 • 5
DOCTOR CALL	ENABLE • DISABLE
PRESS TO TALK	ENABLE • DISABLE
PICTURE MEMORY	Pictures Screen
	All saved pictures are erased. • Zoom X 6 • Wide X 6 • Zoom X 3, Wide X 3 • Wide X 3, Zoom X 3
CALL DURATION	30 sec. • 45 sec. • 60 sec. • 90 sec. • 120 sec.
NIGHT ILLUMINATION	ENABLE • DISABLE
ALARM INPUT	DISABLE • N/O • N/C
EXTERNAL INPUT (S1 to S3)	DISABLE • UTILITY • SECURITY
UTILITY-SENSOR	Detection Alarm timer
	N/O • N/C 10 sec. • 1 min. • 10 min. • 1HOUR • CONT
SECURITY-SENSOR	Detection Alarm timer Alarm Transfer
	N/O • N/C 10 sec. • 1 min. • 10 min. • 1HOUR • CONT ENABLE • DISABLE
DEPARTURE TIMER SETTING	0 sec. • 30 sec. • 60 sec. • 120 sec. • 300 sec. • 600 sec.
ARRIVAL TIMER SETTING	0 sec. • 30 sec. • 60 sec. • 120 sec. • 300 sec. • 600 sec.
SECURITY PIN	▲ • ▶ • ▼ • ◀
RESET SETTING	ENABLE • DISABLE
GUARD (GUARD 1 to 4)	GUARD • RECEPTION • CONCIERGE • NOT DISPLAYED

* are initial settings.

- 1 After performing steps 1 in section 6-1, select "INITIALIZE" in the "INSTALLATION" screen and press the [MENU] button.
- 2 Press the [MENU] button in the "INITIALIZE" screen to perform initialization. Press the [REC/PLAY] button to cancel initialization and return to the previous screen.

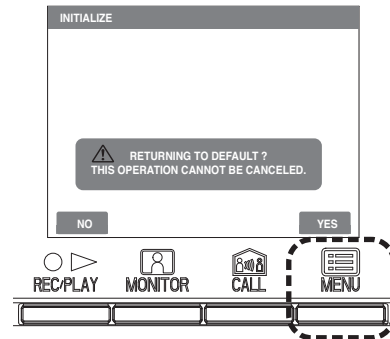

- 3 The status LED and tone off LED light up during initialization. The screen goes out when initialization is complete. (The status LED blinks.)

7 TECHNICAL PRECAUTIONS

TECHNICAL PRECAUTIONS

- Operating temperature: Entrance station: -10 to +60 (+14 °F to +140 °F)
Residential station: 0 to +40 (+32 °F to +104 °F)
Security guard station: 0 to +40 (+32 °F to +104 °F)
Control unit: 0 to +40 (+32 °F to +104 °F)
- Mounting location: Do not install the entrance station in a place where there would be a bright light behind a visitor (or where there would be a bright background) or in a place where the camera lens would be directly exposed to sunlight or a bright light. Entrance stations (integrated type) include a people sensor. Do not place objects such as plants or trees in places monitored by the sensor.
Also, placing the unit in very bright sunlit areas may prevent the sensor from working properly.
- Rain hood (option): Although the entrance station is weather resistant, it is recommended that it not be directly exposed to weather conditions. The rain hood can be installed to protect the entrance station from rainfall.
- Post-replacement setup: After all wiring is completed and the residential station has been replaced, turn off the power to the GT-BC temporarily and then turn it back on.
Next, reprogram the relevant residential station.
- Cleaning: Clean the units with a soft cloth dampened with a neutral household cleanser. Do not use any abrasive cleaner or cloth. The sensitivity of the sensor on an entrance station (Integrated type) will be reduced if it is dirty. Periodically perform cleaning.
- Repair requests: When units do not operate properly, request a qualified technician for repairs.

Warranty

Aiphone warrants that its products have no material or workmanship defects under normal use conditions for two years after delivery to the end user. Aiphone will perform repair or replacement free of charge if the product is defective and the warranty applies to the defect. Aiphone reserves unto itself the sole right to make the final decision whether there is a defect in materials and/or workmanship and whether or not the product is under warranty. This warranty shall not apply to any Aiphone product which has been subject to misuse, neglect, accident, or to use in violation of instructions furnished, nor extended to units which have been repaired or altered outside of the factory. This warranty does not cover batteries or damage caused by batteries used in connection with the unit. Any repairs must be made at the shop or place designated in writing by Aiphone. Aiphone will not be responsible for any costs incurred during on-site service calls. Aiphone will not provide compensation for any loss or damage incurred by the breakdown or malfunction of its products during use, or for any consequent inconvenience or losses that may result.

 (WEEE) indicates applicability to the EU.

This equipment has been tested and found to comply with the limits for a Class B digital device, pursuant to Part 15 of the FCC Rules. These limits are designed to provide reasonable protection against harmful interference in a residential installation. This equipment generates, uses, and can radiate radio frequency energy, and if not installed and used in accordance with the instructions, may cause harmful interference to radio communications. However, there is no guarantee that interference will not occur in a particular installation. If this equipment does cause harmful interference to radio or television reception, which can be determined by turning the equipment off and on, the user is encouraged to try to correct the interference by one or more of the following measures: • Reorient or relocate the receiving antenna • Connect the equipment into an outlet on a circuit different from that to which the receiver is connected. Increase the separation between the equipment and receiver. • Consult the dealer or an experienced radio/TV technician for help.



AIPHONE CO., LTD., NAGOYA, JAPAN
AIPHONE CORPORATION, BELLEVUE, WA, USA
AIPHONE S.A.S., LISSES-EVRY, FRANCE