

*TD-H Series*  
**SELECTIVE CALL INTERCOM**

- Models: **TD-1H/B** (1-call)  
**TD-3H/B** (3-call)  
**TD-6H/B** (6-call)  
**TD-12H/B** (12-call)  
**TD-24H/B** (24-call)

**INSTALLATION & OPERATION MANUAL**

**CONTENTS**

1 SYSTEM OUTLINE & COMPONENTS.....1  
 2 NAMES & FEATURES .....2  
 3 PRECAUTIONS ON INSTALLATION & WIRING .....3  
 4 WIRING.....4 ~ 9  
 5 MOUNTING.....10  
 6 OPERATIONS on TD-H.....11  
 7 CLEANING THE EQUIPMENT .....12  
 8 TECHNICAL PRECAUTIONS .....12  
 9 SPECIFICATIONS.....12

**1 SYSTEM OUTLINE & COMPONENTS**

■ **System outline**

TD-H/B is a multi-channel selective-call intercom. On loop-wiring, five TD-H station models, intermixable, can be configured to all-master, master-selective system or mixed. Additionally, using a potential station(s), PanTilt MY and/or audio IE/IF door stations (2 max.) and paging zone(s) may be incorporated.

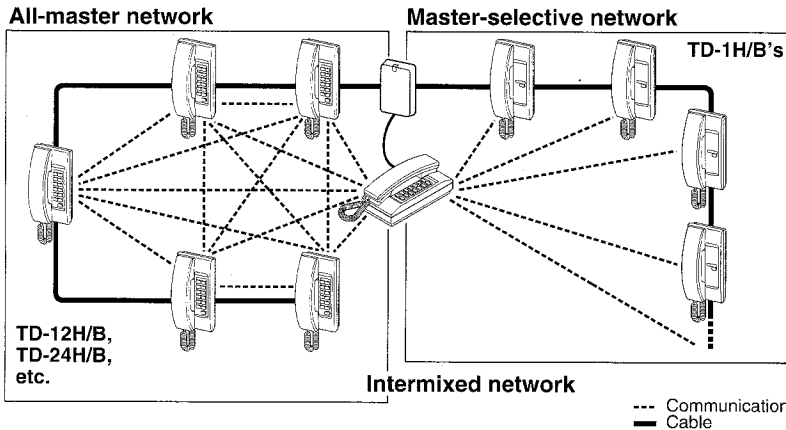

■ **Package contents**

- TD-H phone station
- Packet of screws
- Installation & Operation Manual

■ **Components available**

• **Intercom master stations:** Intermixable

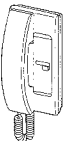
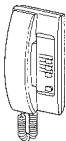
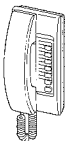
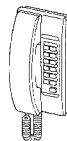
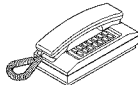
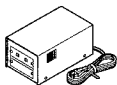

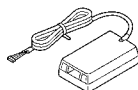

<b>TD-1H/B</b> 1-call sub 	<b>TD-3H/B</b> 3-call 	<b>TD-6H/B</b> 6-call 	<b>TD-12H/B</b> 12-call 	<b>TD-24H/B</b> 24-call 	<b>PS-12A or PS-12C</b> Power supply 
---	---	---	---	---	--

**TDW-1~24/A**

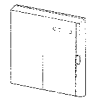

Terminal box with 1.5m, 5 feet cord for connecting TD-nH for desktop use, or surface wall mounting.

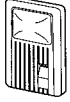
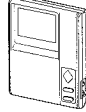
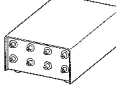
■ **Optional accessories**

<b>DE-UR</b> Door station adapter 	<b>IF-DA</b> Door station 	<b>MY-DC/A</b> PanTilt video 	<b>MY-CU</b> Video-monitor 	<b>PD-2</b> Paging adaptor 	<b>RY-AC/A</b> Call extension relay 
	<ul style="list-style-type: none"> <li>• IE/IF Series IE-JA, IE-NC, IE-DC, etc.</li> </ul>	<ul style="list-style-type: none"> <li>• MY Series MY-DG/A, MY-EA, MY-FA, MY-CA, etc.</li> </ul>	<ul style="list-style-type: none"> <li>• MYH-CU Sub-monitor</li> </ul>	<ul style="list-style-type: none"> <li>• PD-1, no talkback</li> </ul>	

## 2 NAMES & FEATURES

■ **Names & functions**

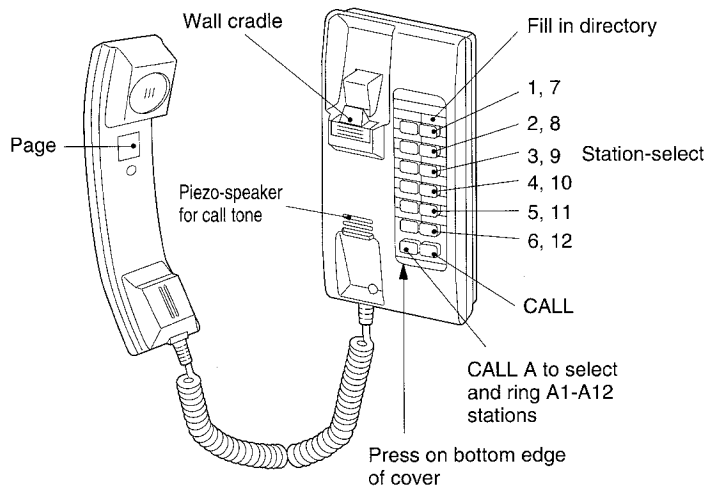

**TD-24H/B**

■ **Features**

- \* Intercom communication among 25 stations (max.) in all-master configuration. Single-master system, with TD-1H/B station, or intermixed.
- \* Intermixable five TD-H station models in a system
- \* Multiple talk paths for intercom (and paging)
- \* Station-select break-in call
- \* Max. 28 conductor cable, station to station
- \* PanTilt video or audio door station (2 per system)
- \* Incorporates a zone(s) for paging (with talkback)
- \* Call extension buzzer or light

■ **Handset cradle**

Reversely attach wall-mount cradle for desk use.

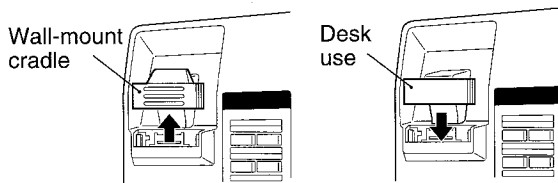

■ **Cable clamp**

Two cable clamps (parts) are included on every TD-nH chassis. See page 10.

■ **Directory card**

For TD-24H/B, fill in names on 2 lines, aligning with the right sample.

<b>AIPHONE TD-24H</b>	
President	
A Conf. 1	A
1	7
Reception	
A Conf. 2	A
2	8
A	A
3	9
A	A
4	10
A	A
5	11
A	A
6	12
CALL A	CALL

### 3 PRECAUTIONS ON INSTALLATION & WIRING

#### ⚠ CAUTION

- ★ Do not connect any terminal on any unit to AC power lines to prevent fire or unit damage.
- ★ Do not install more than one power supplies PS-12A (or PS-12C) for an entire TD-H system, including adaptors for door station and/or paging.
- ★ Do not attempt to install or connect wires on TD-H equipment while system's power supply is plugged in.
- ★ TD-H masters and related equipment, except door station, are designed for indoor use only. Do not install outdoors.
- ★ Do not connect any other power source than specified on terminals +, -. Doing so can damage the TD-H equipment.

#### IMPORTANT

- ★ For system's installation, there is no need to disassemble the equipment. Do not open any TD-H system components unless properly qualified.
- ★ Any other manufacturer's products installed with this system (power supply, external signalling device, etc.) are not covered under Aiphone's warranty.
- ★ Do not mount TD-H equipment in the following places, as it may cause the system to malfunction:
  - High or extreme cold temperature areas: under direct sunlight, near equipment that varies in temperature, in front of air-conditioner, inside a refrigerated area, etc.
  - Places subject to moisture or humidity extremes.
  - Places subject to environmental conditions, such as dust, oil, chemicals, etc.
- ★ TD-H is an electrical device, which must not be subjected to water, or any other liquid.
- ★ Weather conditions, such as lightning storms, may cause damage to TD-H equipment. We recommend that power surge protection be installed as follows: (However, this does not guarantee that no damage will occur).

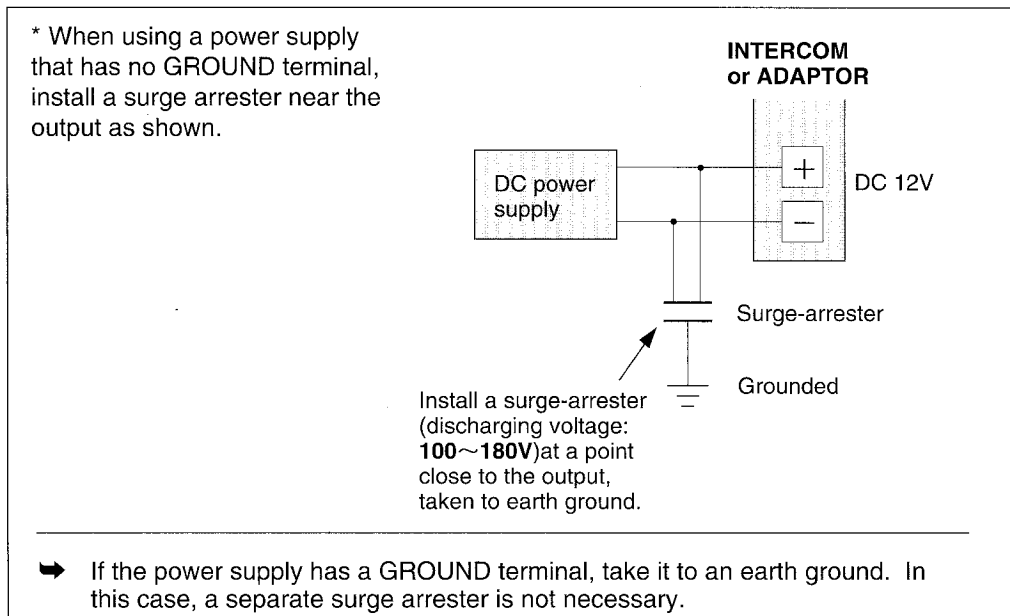

- Before actually installing the TD-H system, the contents on pages 4 ~ 10 must be thoroughly read and understood.

# 4 WIRING

## ■ All-master system configurations

TD-H is basically designed for making all-master system on looped trunk cable, as per table below;

Models	Station capacity	Cable required (*)
TD-3H/B	4 stations	7-conductor cable
TD-6H/B	7 stations	10-conductor cable
TD-12H/B	13 stations	16-conductor cable
TD-24H/B	25 stations	28-conductor cable

(\*) Includes a conductor for D terminal required for a DE-UR(s)

TD-1H/B, 1-call sub provides TD-3H/B ~ 24H/B all-master network with own communication points (intermixed system).

## ■ Cable requirements

Use multiconductor cable (non-twisted), 0.65 ~ 0.8mm dia., 22~ 20AWG, to accommodate maximum number of intercom stations, and featured audio or PanTilt video door station(s) and/or page to a zone(s), each of which uses one potential wire.

## ■ Terminal - block layout ★Two cable clamp tips are attached on chassis. (See page 10)

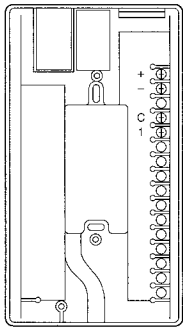

TD-1H/B

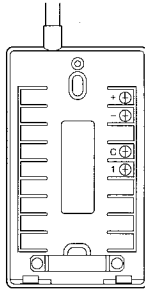

TDW-1/A

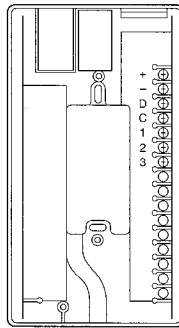

TD-3H/B

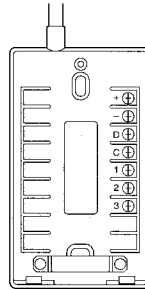

TDW-3/A

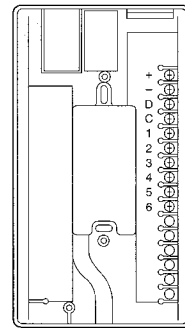

TD-6H/B

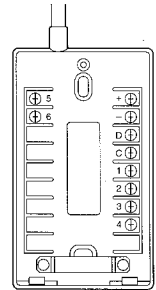

TDW-6/A

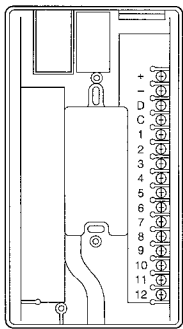

TD-12H/B

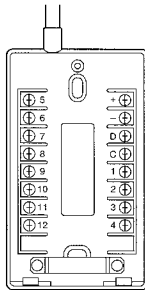

TDW-12/A

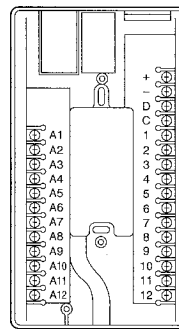

TD-24H/B

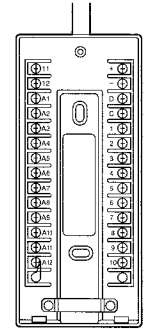

TDW-24/A

### Meaning of terminal symbols

**No. 1 ~ 24** are selective station points, providing selective calling and communication for master-to-master communication.

**C terminal** is a call tone signal receive terminal.

**D terminal** is a door station call tone line.

**+, - terminals** are 12V DC power supply lines.

## ■ Power supply

Entire TD-H intercoms can be powered by a single PS-12A(12C) power supply, and locate it in the center of the trunk cable. It can also power directly such adaptors as DE-UR, PD-1 & PD-2, which must be all located within 5m, 16' distance from PS-12A(12C).

## TD-H single-master system

TD-3H/B ~ TD-24H/B makes a single-master network, using TD-1H/B 1-call station to call the master station. TD-1H/B with CALL button only, is allowed to call TD-H master station only.

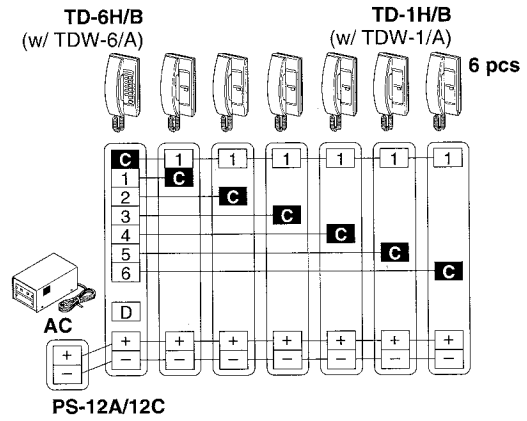

## TD-H all-master system

TD-H all-master system can be made by running parallel conductors from station to station. No. of conductors required is: 2 common (or 3 with D line) plus number of TD-H stations installed. As shown, one more TD-H station (the last #) may be added on each own No. button.

### TD-3H/B

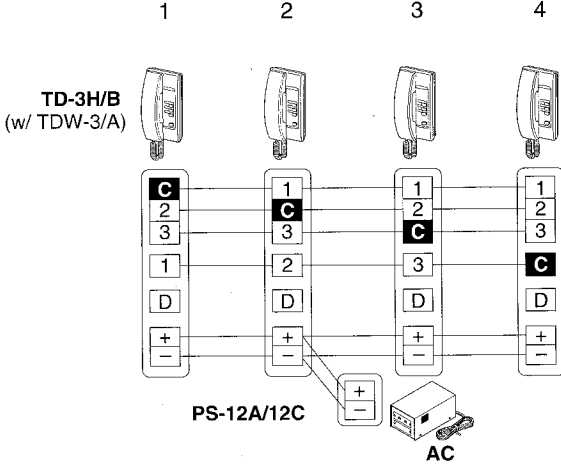

### TD-6H/B

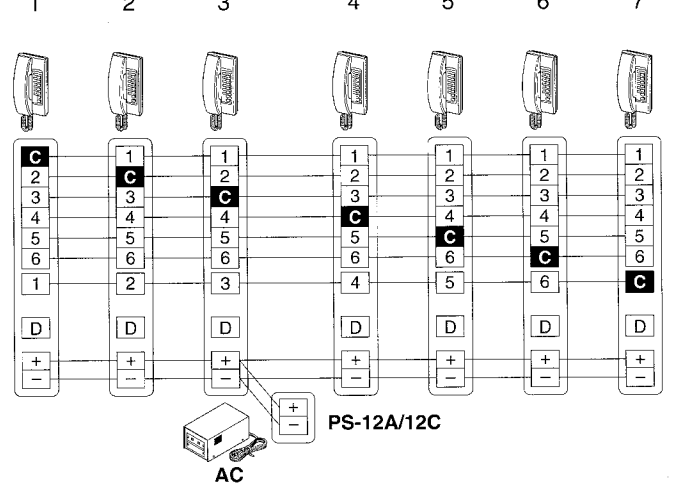

### TD-12H/B

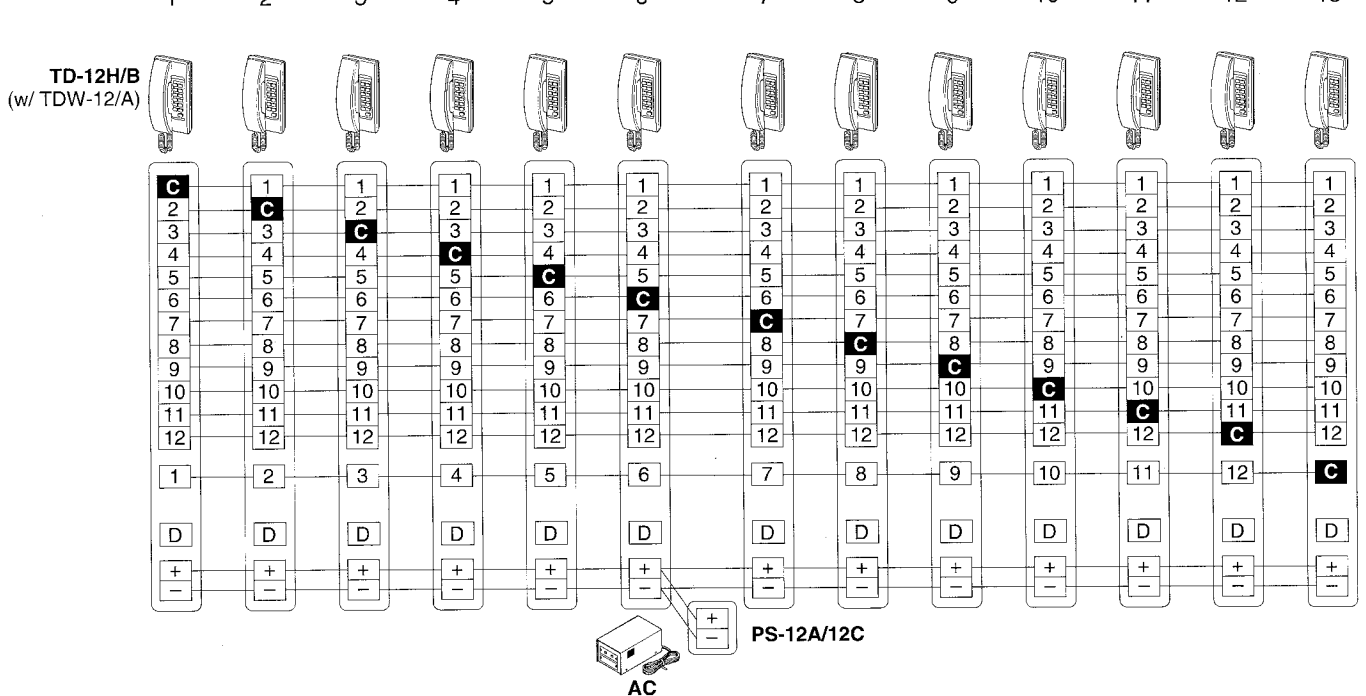

## TD-H all-master system

### TD-24H/B

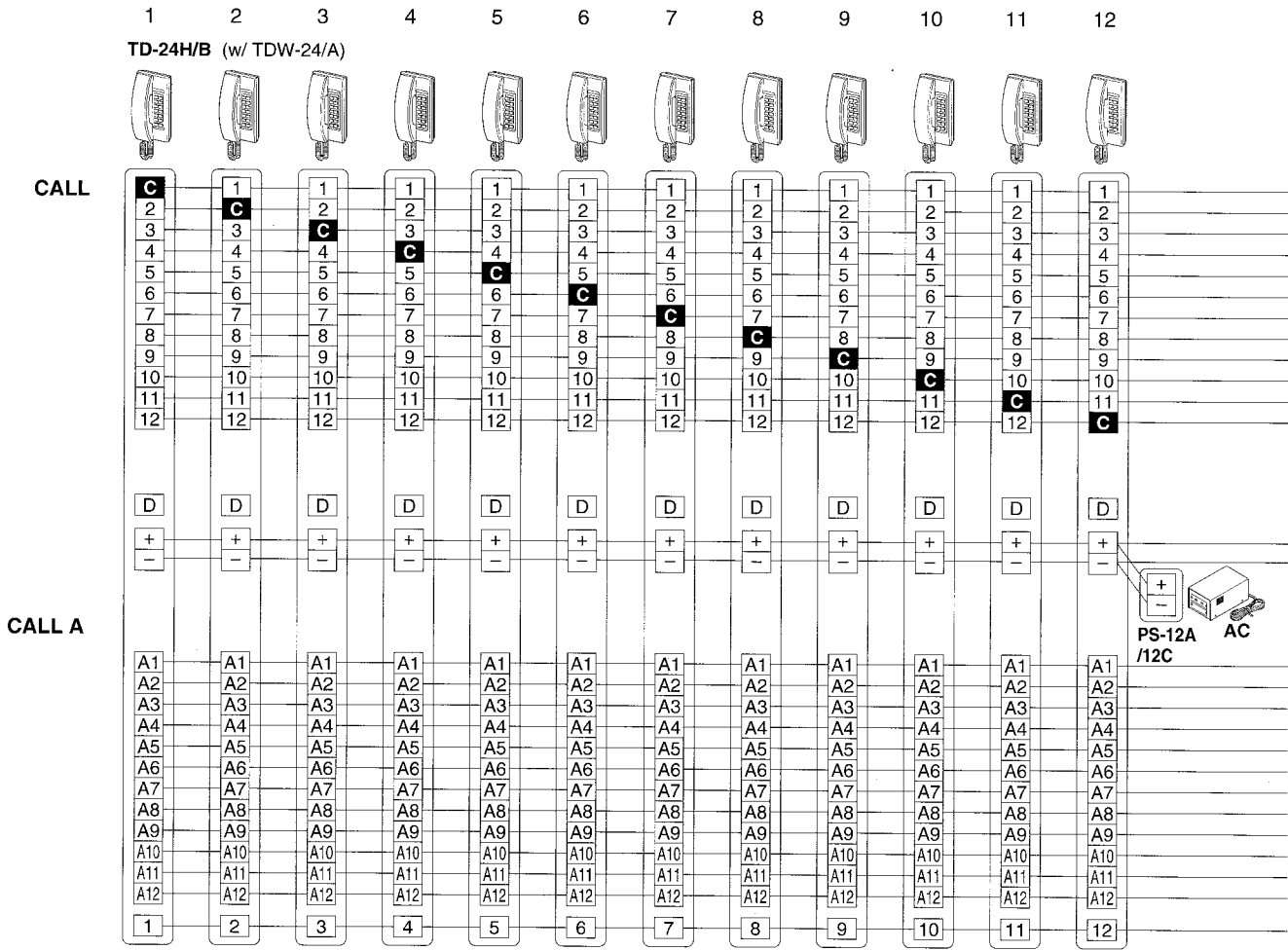

## TD-H intermixed system

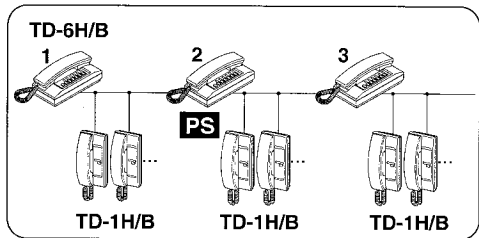

Intermixed system is an all-master & single-master combined within a system. Each TD-H master station may have additional contacts with TD-1H/B, 1-call station (s).

TD-1H/B stations can be wired to the TD-6H/B master station, using unused conductors in the trunk cable

### TD-6H/B (w/ TDW-6/A)

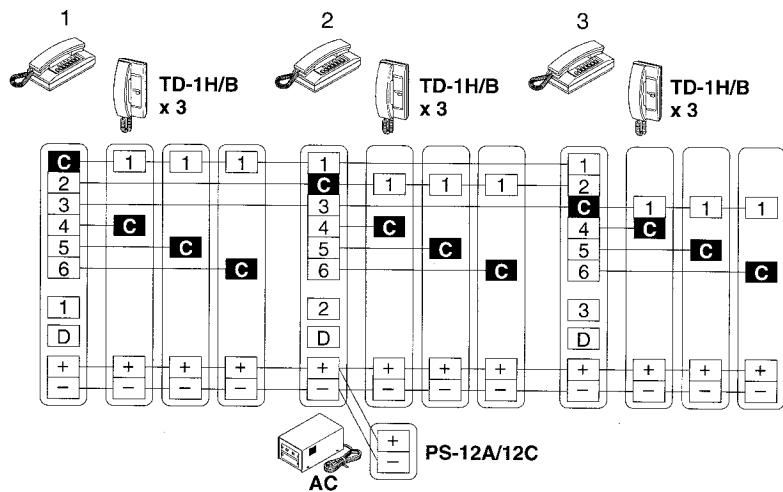

### Cable requirements

Use a multi-conductor (non-twisted) cable 0.65 ~ 1.0 mm dia., 22 ~ 18AWG for TD-H intercoms.

### Wiring distance

TD-H intercoms (any communication)

Diameter	0.65mm	0.8mm	1.0mm	AWG	22AWG	20AWG	18AWG
Distance	650m	1,000m	1,500m	Distance	2,000'	3,000'	4,900'

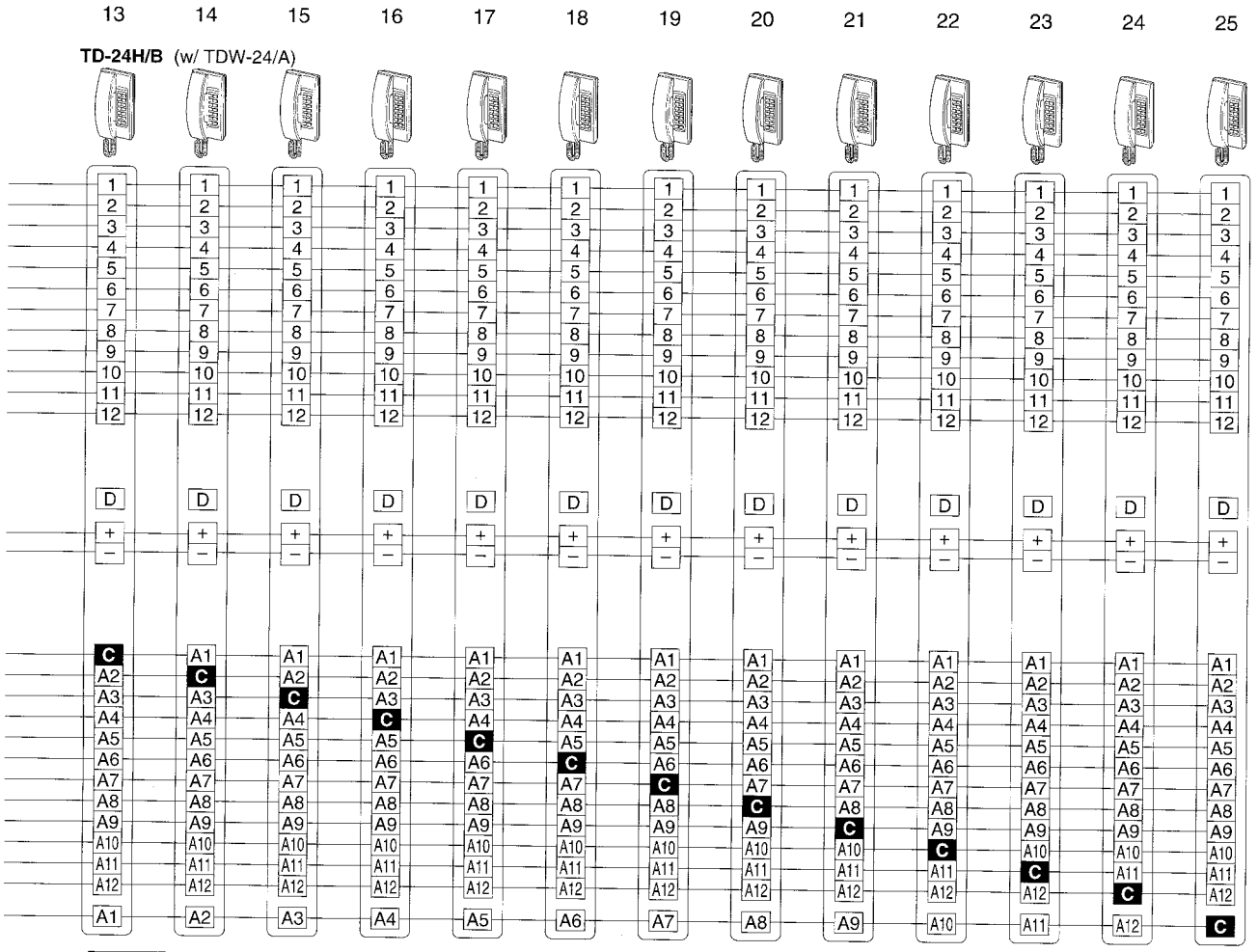

■ Audio door station IE/IF series

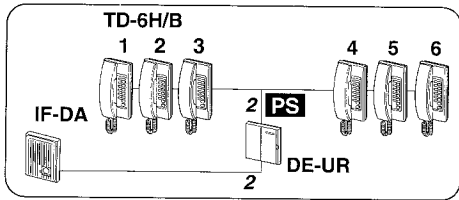

TD-H system may have one or two audio door station IE/IF series, using a potential station. Intermittent tremolo rings at max. 12 TD-H phones. For 2nd door station, change SW. to B position on DE-UR, to change call tone faster.

- From DE-UR to IF-DA, etc.

Diameter	0.65mm	0.8mm	1.0mm
Distance	150m	230m	350m
AWG	22AWG	20AWG	18AWG
Distance	500'	700'	1,100'

- From DE-UR to power supply

Diameter	0.65mm	0.8mm	1.0mm
Distance	10m	15m	20m

AWG	22AWG	20AWG	18AWG
Distance	30'	50'	65'

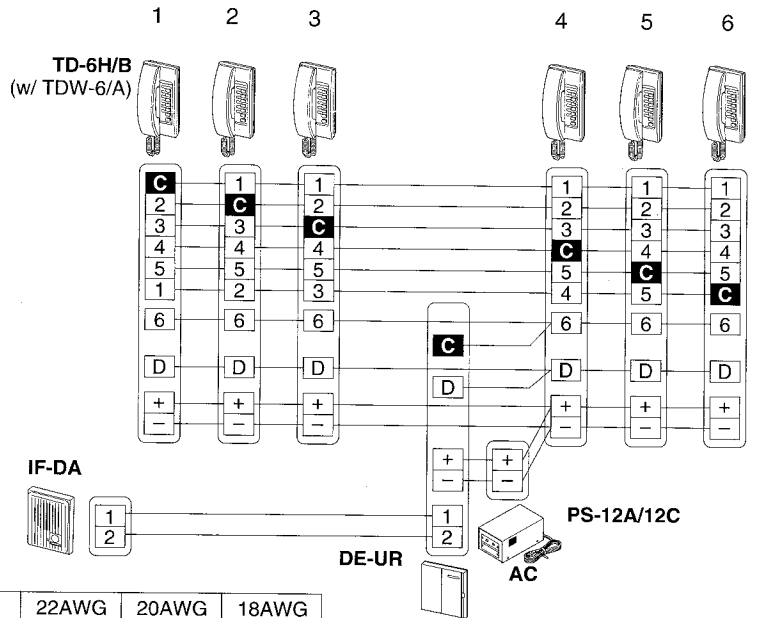

## ■ PanTilt video integration to TD-H

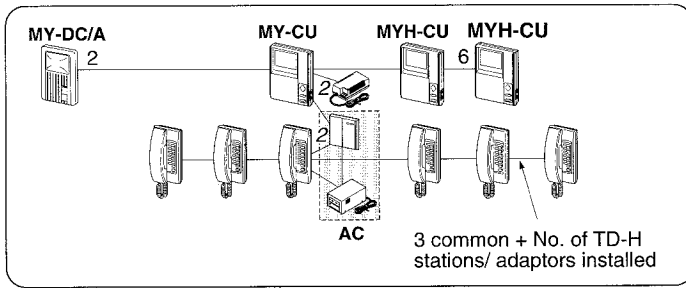

When MY-DC/A calls in, TD-6H/B stations receive an intermittent call tone, with an image on video-monitors. Pick up and select the assigned # station to reply.

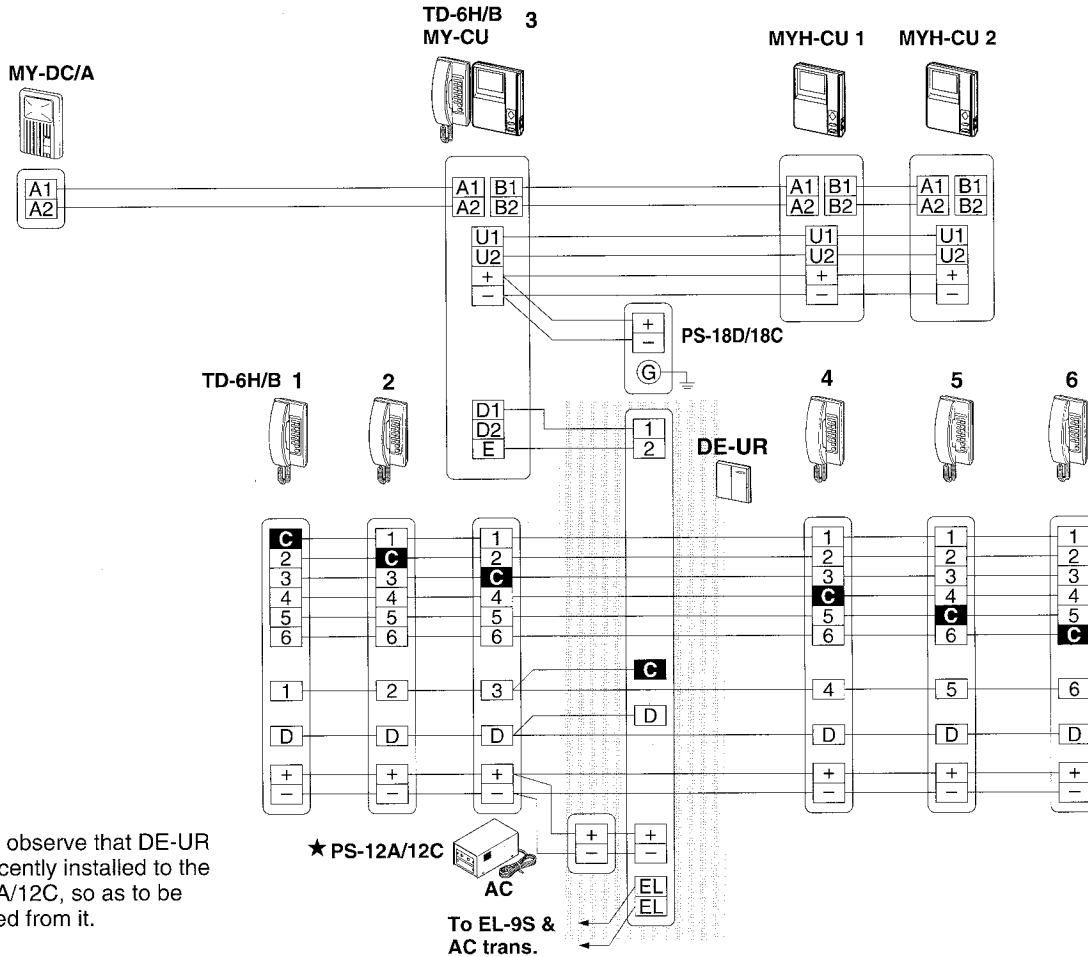

★ Strictly observe that DE-UR is adjacently installed to the PS-12A/12C, so as to be powered from it.

★ PS-12A/12C

To EL-9S & AC trans.

### MY-CU cable requirements & power supply

2 conductors (non-twisted) from MY-CU to MY-DC/A.  
6 conductors (non-twisted) from MY-CU to MYH-CU sub-monitors with no extra conductors in the cable.

#### Wiring distance

- From MY-CU to power supply
- From MY-CU to PanTilt door MY-DC/A

Diameter	1.0mm
Distance	5m
AWG	18AWG
Distance	16'

Diameter	0.65mm	0.8mm	1.0mm
Distance	50m	65m	100m
AWG	22AWG	20AWG	18AWG
Distance	165'	210'	330'

- Between TD-H intercoms (any pair)

Diameter	0.65mm	0.8mm	1.0mm
Distance	650m	1,000m	1,500m
AWG	22AWG	20AWG	18AWG
Distance	2,000'	3,000'	4,900'

- From DE-UR to power supply

Diameter	0.65mm	0.8mm	1.0mm
Distance	10m	15m	20m
AWG	22AWG	20AWG	18AWG
Distance	30'	50'	65'

- From MY-CU to MYH-CU #1 (2 monitors)

Diameter	0.65mm	0.8mm	1.0mm
Distance	35m	50m	75m
AWG	22AWG	20AWG	18AWG
Distance	115'	150'	250'

- From MY-CU to MYH-CU #2 (3 monitors)

Diameter	0.65mm	0.8mm	1.0mm
Distance	20m	30m	50m
AWG	22AWG	20AWG	18AWG
Distance	65'	100'	150'



## ■ Paging adaptors PD-1 and PD-2

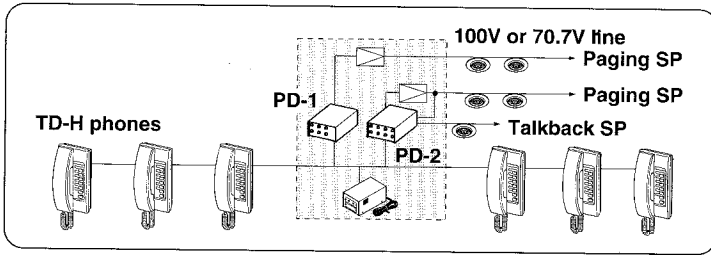

- PD-1 or PD-2 controls each paging zone, using an amp. & paging speakers.
- Multiple paging zones and channels.
- One PD-2 for paging with talkback.
- Must be powered by TD-H's power supply PS-12A/12C.
- Use paging speakers SP-3NA (SP-5N in USA).
- Connection to background music source.

### • PD-1 paging adaptor

### • PD-2 paging adaptor w/ talkback

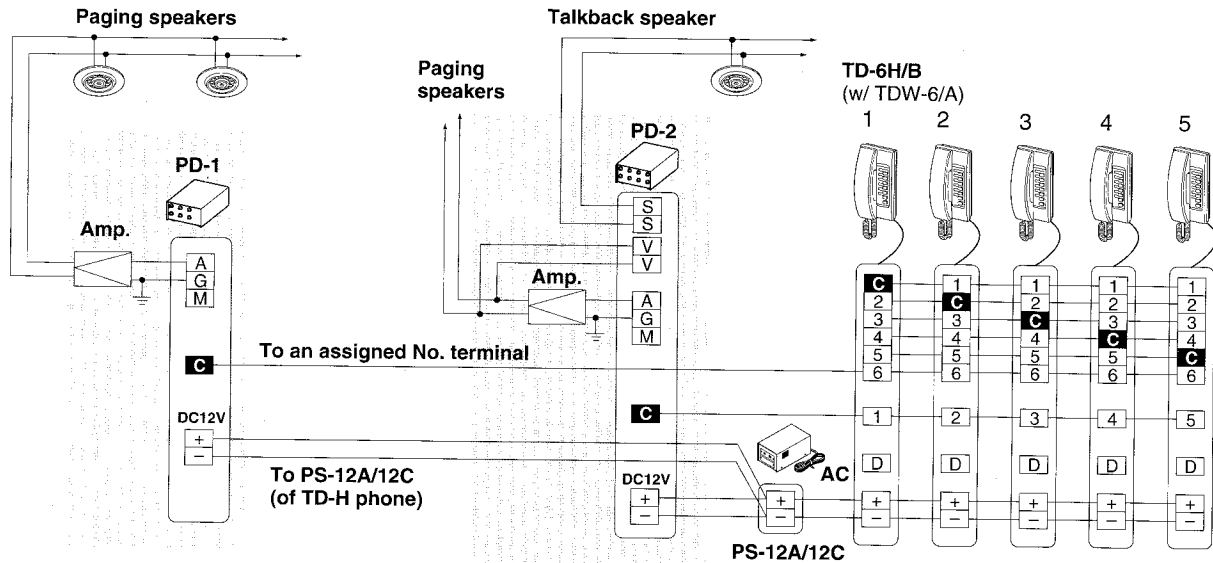

## ■ Call extension relay RY-AC/A

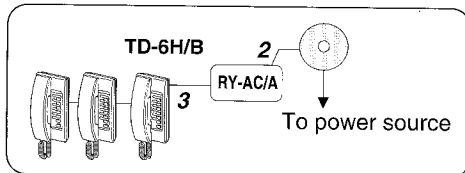

RY-AC/A will activate when station #3 receives a call from a handset station. It lasts as long as that TD-H station is ringing.

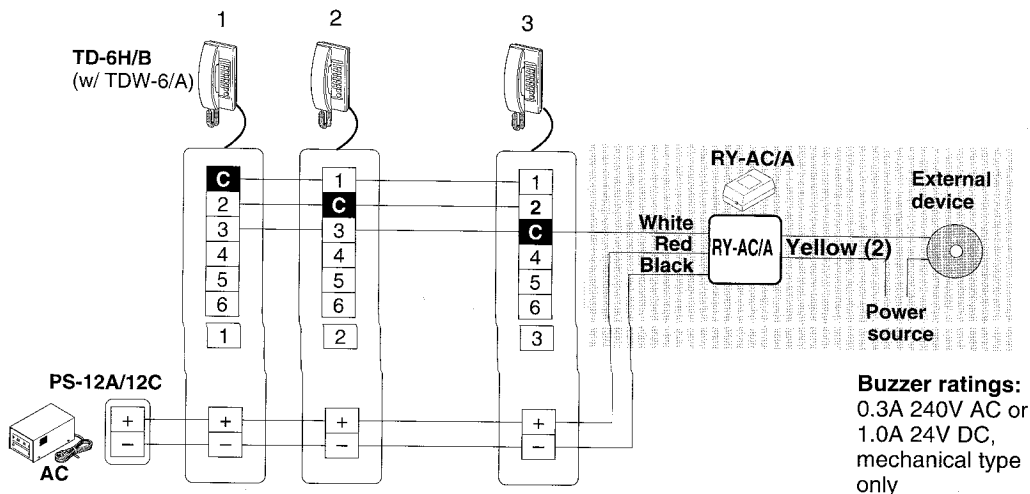

# 5 MOUNTING

- ★ **Make sure PS-12A/12C is unplugged while making wiring connections.**
- ★ When drawing out a TD-H station's wires from trunk cable, connect each junction with secured insulation. Or use TDW-n terminal box, allowing plug-in to TD-nH on 1.5m cord end.

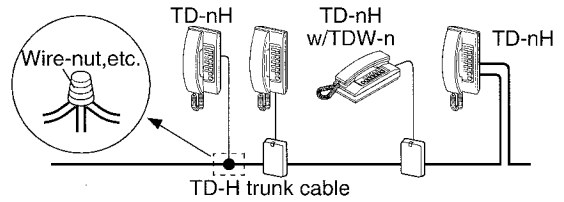

## ■ TD-nH wall-mounting (on gang box)

1. Loosen a front bottom screw.
  2. Lift the front case off the chassis, and unplug CN1 ~ 3 connectors (varies by model) to disconnect intercom.
  3. Mount the chassis to single-gang box with 2 screws supplied.
  4. Make wire termination on each screw terminal inside the chassis.
  5. Plug in CN connectors back to each socket.
  6. Remount front case to chassis, fastening bottom screw.
- ★ Put together the connector leads to avoid pinching by hook knob or front case.

CN connectors: **CN-1** on TD-1H/B, 3H/B  
**CN-1, 2** on TD-6H/B, 12H/B  
**CN-1 ~ 3** on TD-24H/B

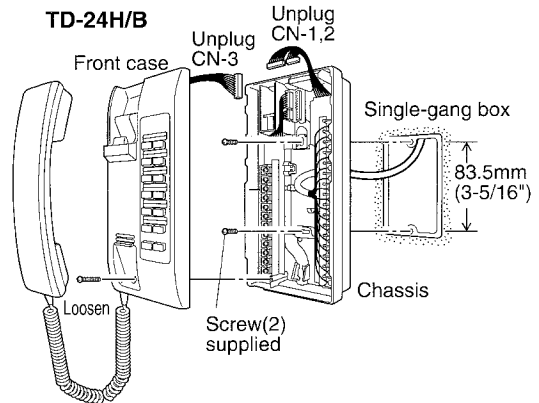

## ■ TD-nH desk or surface wall mounting

Use TDW-n box for either desk-top or surface wall mounting.

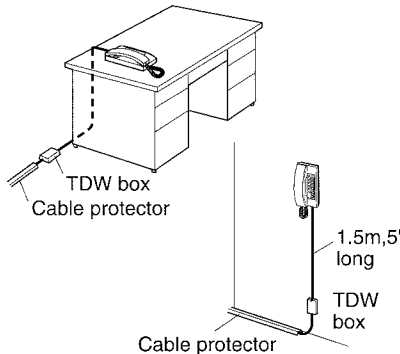

- ★ Install TDW-n and cable in non-trapping manner.

- ★ **Anchor TDW-n cord on the chassis**

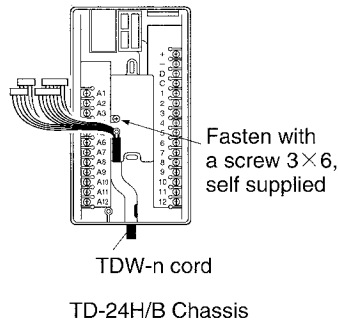

- ★ **Fasten TDW-n cord or station cable with a clamp** (Cut off the parts from TD-1~12H/B chassis).

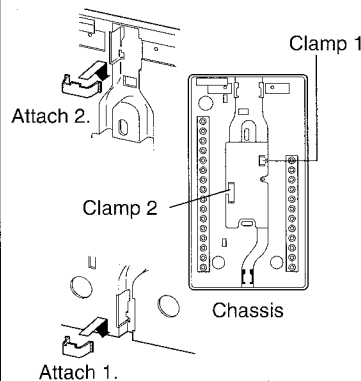

Connecting TDW-n to TD-nH

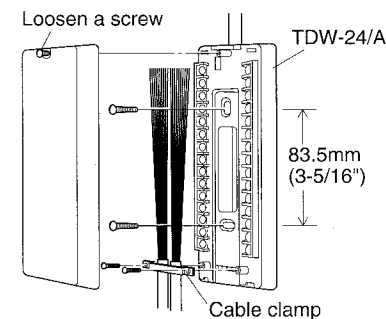
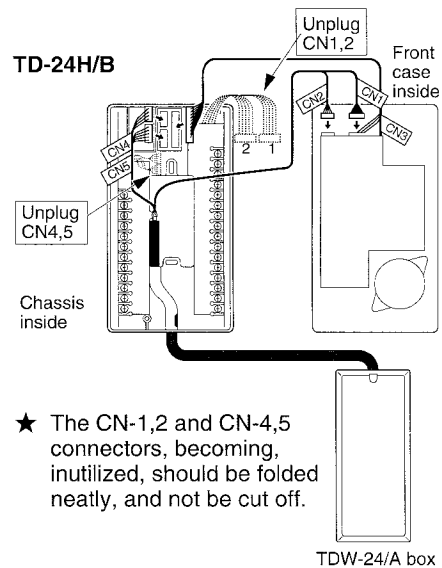

TD-3~12H/B

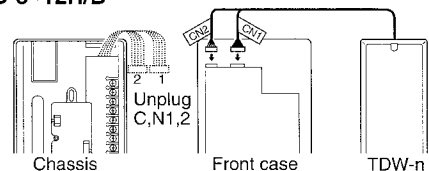

CN2 : TD-6H/B & TD-12H/B only

# 6 OPERATIONS on TD-H

Station # button selects a TD-H intercom, a zone for page, or a door station.

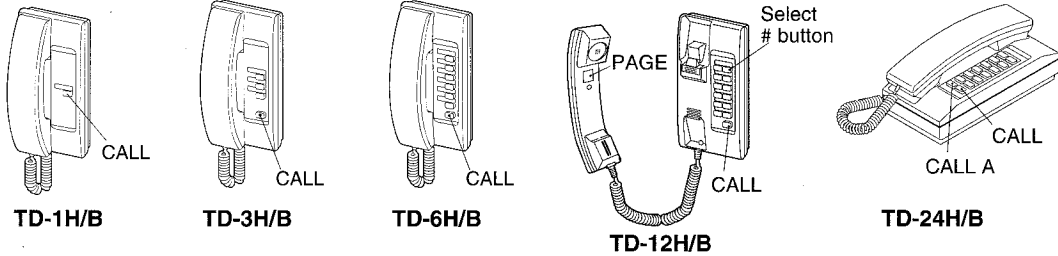

## Basic operations

### Calling other TD-H

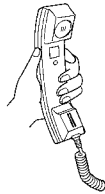

Pick up TD-H handset.

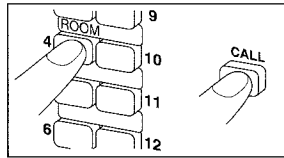

Depress to lock a station-select button and press CALL button momentarily.

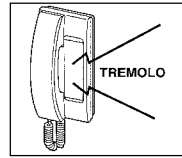

The TD-H station rings tremolo tone. Pick up handset to reply.

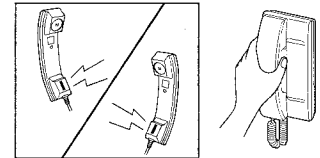

Communicate with handset on both stations. After communication, both stations hang up.

- ★ On TD-24H/B, depress CALL A to call A1~A12 stations.
- ★ If handset is not replaced, that station will not ring.



### Receiving a call from TD-H

When tremolo tone rings on your TD-H station, simply pick up to reply.

## To talk with a door station

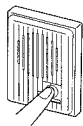

Call button is depressed.

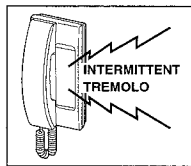

Tremolo tone rings for approx. 2.5 seconds.

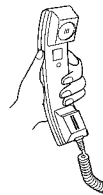

Pick up the TD-H handset. Depress to lock a door-assigned # button.

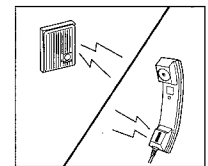
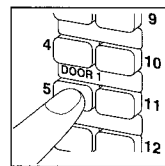

Reply to door station.

## Zone page

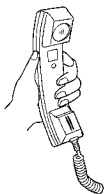

Pick up handset.

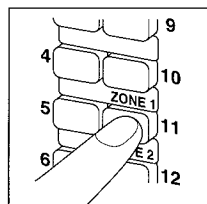

Depress to lock a zone-assigned # button.

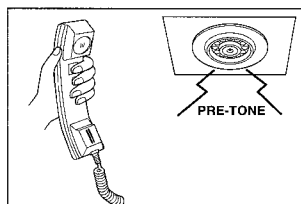

Depress PAGE button inside handset. Pre-tone notifies through zone's speakers

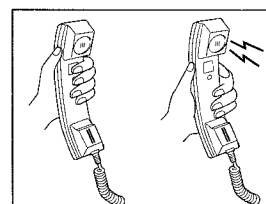

Page while holding down PAGE button. Release PAGE button to receive talkback reply. (with PD-2 only)

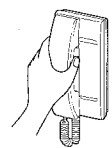

Hang up handset.

## Call extension buzzer

Using the RY-AC/A relay, a call from another TD-H or door station activates a separate buzzer (not supplied by Aiphone) while the TD-H station is ringing. Pick up (and select the door) on the TD-H station.

## Multiple talk paths are available for intercom and paging

- ★ If you hear someone speaking after depressing a TD-H station's # button, the station is busy. Hang up and call later.

## Filling in directory

On directory strip, fill in names of other TD-H stations, and door / page zone #'s. Push on bottom of directory cover.

# 7 CLEANING THE EQUIPMENT

1. Clean intercom unit surface with a soft and dry cloth.
2. When the soil is not easily cleaned, the cloth may be dampened with neutral household cleanser. Never use an abrasive cleaner or cloth.

# 8 TECHNICAL PRECAUTIONS

- Door-assigned # button** ★ It is suggested, on TD-24H/B to assign a number button 1 ~ 12 for door station(s) or paging zone(s), so they can be addressed by depressing only the station # button. Do not use A1 ~ A12.
- Station select break-in call** ★ TD-H allows any station(s) to join on the conversation by station selection.
- Paging** ★ Do not select and page to more than one zone simultaneously.

# 9 SPECIFICATIONS

<b>Power source</b>	DC 12V. Max. 70mA per station. Use PS-12A or PS-12C power supply for a system.														
<b>Calling</b>	Station-select button 1 ~ 12 and Call button, rings with tremolo tone. Rings while Call button is held down. (On TD-24H/B, 1 ~ 12 and Call A button rings A1 ~ A12 stations)														
<b>Communication</b>	Multi-talk path, simultaneous intercom. When called by tremolo from other station, pick up the handset.														
Added feature counts as a station, assigning a select # button (any) on TD-H station(s).															
<b>Door station</b>	<b>Max. 2 door stations</b> IE/IF Series or PanTilt video, using DE-UR for each. Rings max. 12 TD-H stations with intermittent tremolo, 2.5 sec.-timed. ★ Call tone selector A or B on DE-UR for 2 doors.														
<b>Zone page</b>	<b>Multiple zones</b> , using a PD-1 or PD-2 (w/talkback), amplifier and an appropriate number of speakers for each.														
<b>Wiring</b>	<table border="1" style="margin-left: auto; margin-right: auto;"> <tr> <td style="text-align: center;">TD-1H/B</td> <td style="text-align: center;">TD-3H/B</td> <td style="text-align: center;">TD-6H/B</td> <td style="text-align: center;">TD-12H/B</td> <td style="text-align: center;">TD-24H/B</td> </tr> <tr> <td style="text-align: center;">4 cond.</td> <td style="text-align: center;">7 cond.</td> <td style="text-align: center;">10 cond.</td> <td style="text-align: center;">16 cond.</td> <td style="text-align: center;">28 cond.</td> </tr> </table> 3 wires common + 1 for each selective calling					TD-1H/B	TD-3H/B	TD-6H/B	TD-12H/B	TD-24H/B	4 cond.	7 cond.	10 cond.	16 cond.	28 cond.
TD-1H/B	TD-3H/B	TD-6H/B	TD-12H/B	TD-24H/B											
4 cond.	7 cond.	10 cond.	16 cond.	28 cond.											
<b>Wiring distance</b>	650m with 0.65mm diameter. 2,000' with 22AWG.														
<b>Dimensions</b> TD-nH/B (n=1,3,6,12) TD-24H/B	210mm high x 100mm wide x 73mm deep. 8-1/4"H x 3-15/16"W x 2-7/8"D Same, except 83mm, 3-1/4" deep														
<b>Weight</b>	TD-1H/B ... 410g (0.90 lbs.)    TD-3H/B ... 430g (0.95 lbs.)    TD-6H/B ... 440g (0.97 lbs.) TD-12H/B ... 460g (1.01 lbs.)    TD-24H/B ... 520g (1.14 lbs.)														

### WARRANTY

Aiphone warrants its products to be free from defects of material and workmanship under normal use and service for a period of one year after delivery to the ultimate user and will repair free of charge or replace at no charge, should it become defective upon which examination shall disclose to be defective and under warranty. Aiphone reserves unto itself the sole right to make the final decision whether there is a defect in materials and/or workmanship; and whether or not the product is within the warranty.

This warranty shall not apply to any Aiphone product which has been subject to misuse, neglect, accident, or to use in violation of instructions furnished, nor extended to units which have been repaired or altered outside of the factory. This warranty does not cover batteries or damage caused by batteries used in connection with the product.

This warranty covers bench repairs only, and any repairs must be made at the shop or place designated in writing by Aiphone.

Aiphone will not be responsible for any costs incurred involving on site service calls.